

FS-LACRI Insert compatible with Lacrimosa® Assembly Instructions



FS-LACRI

The package contains 4 sheets: one double and two single sheets.

After assembly the trays are put in up to two layers in the original game box.

Ordinary PVA glue is required when assembling each tray.

Please make sure you dry-assemble each tray correctly before gluing it together.

Please check www.foldedspace.com for general assembly tips.

Important: as this is a full colour insert it is particularly needed to both dry assemble and check the trays against the images shown on our website. Many of the trays have colour floral stripes around the outside of the tray and it is important to get these right on each tray before applying glue!

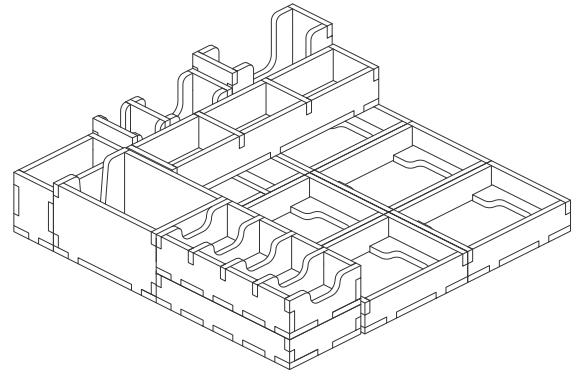

Sheet A1, A2 Sheet B Sheet C

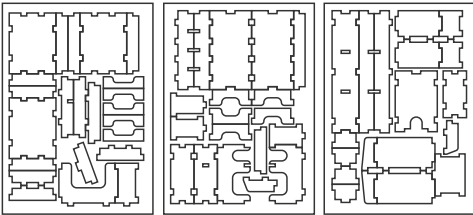

Tray 1

Sheet C

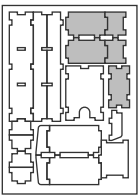

Step 1

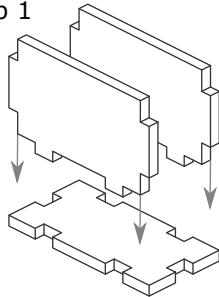

Step 2

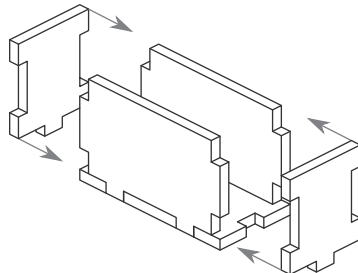

Finished tray

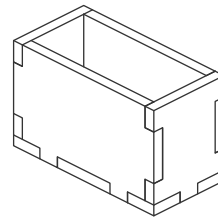

Tray 2

Sheet A1, A2

Sheet B

Sheet C

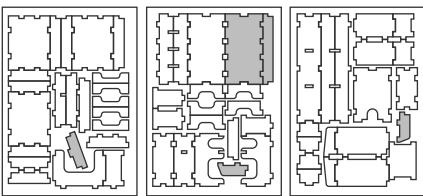

Step 1

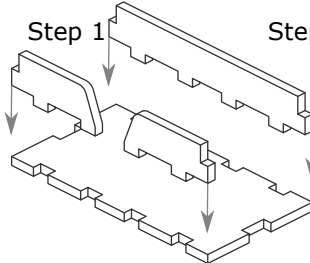

Step 2

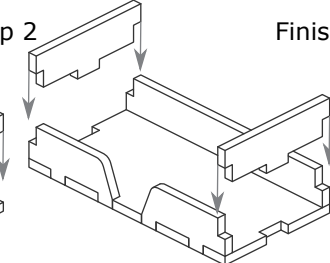

Finished tray

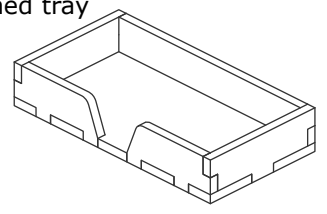

Tray 3

Sheet A1, A2

Sheet B

Step 1

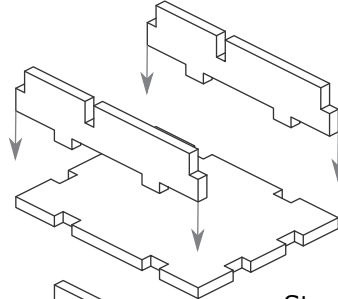
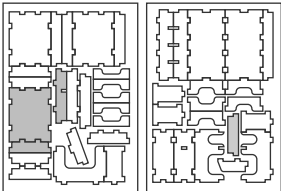

Step 2

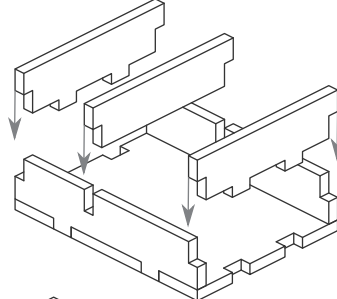

Finished tray

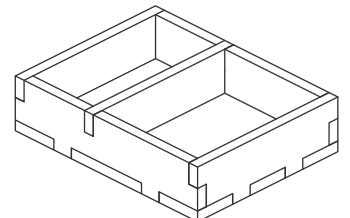

Tray 4

Sheet C

Step 1

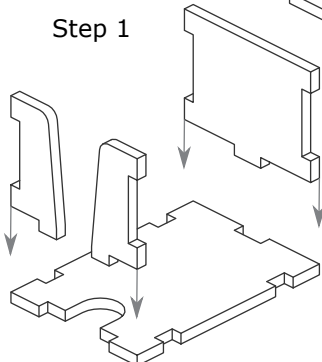
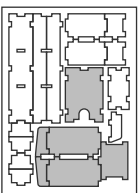

Step 2

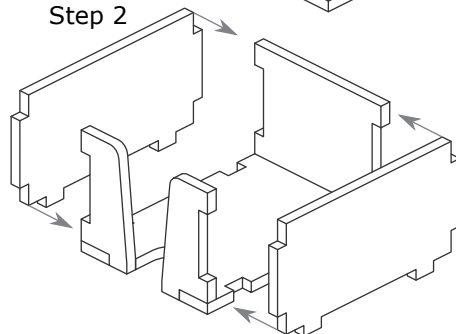

Finished tray

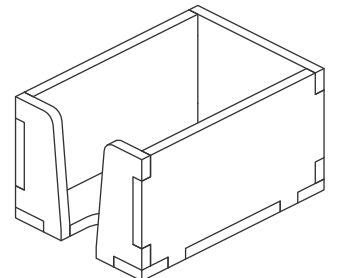

Tray 5a, 5b

Sheet A1, A2 Sheet B

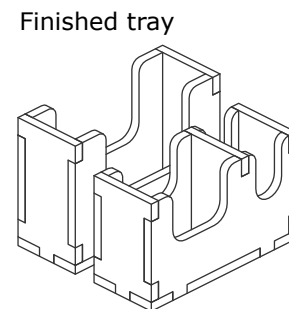
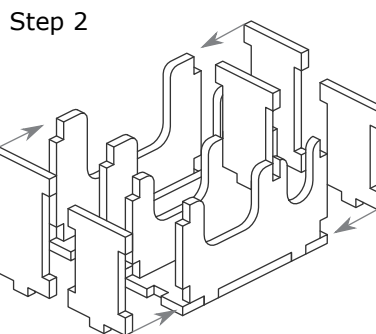
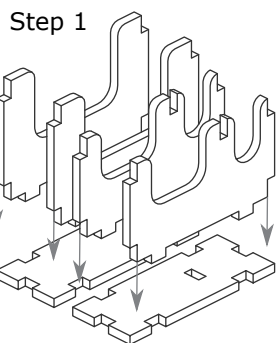
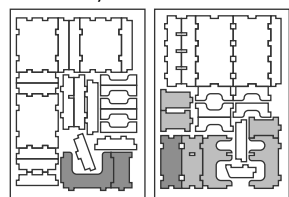

Tray 6

Sheet B

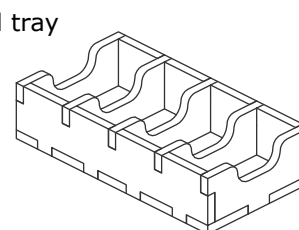
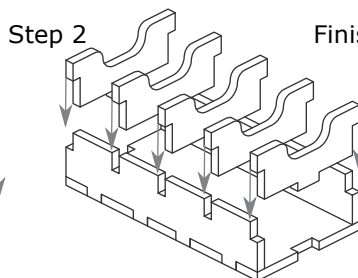
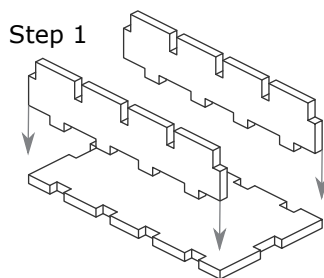
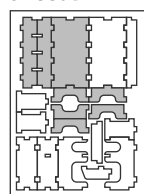

Tray 7a, b, c, d, e

Sheet A1, A2

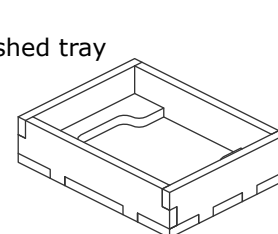
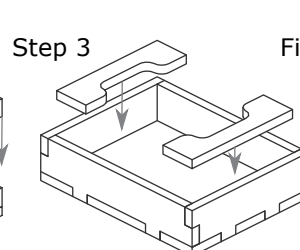
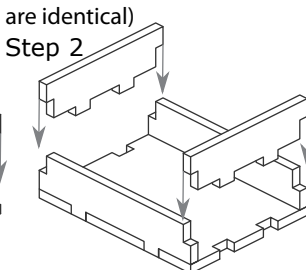
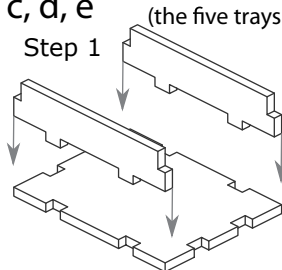
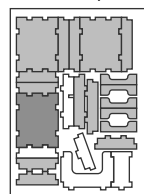

(the five trays are identical)

Tray 8

Sheet C

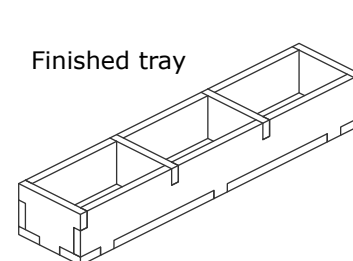
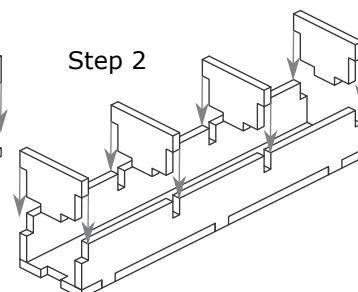
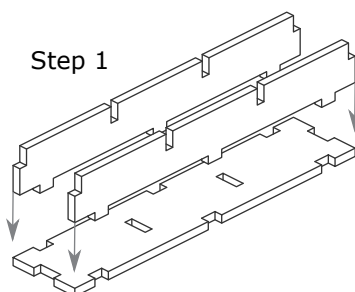
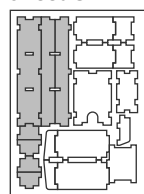

FS-LACRI

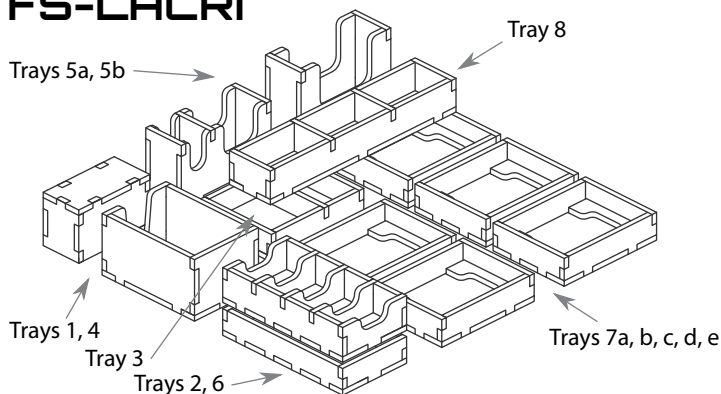

Please check www.foldedspace.net for photos of this insert in use.

Tray legend:

- Tray 1 - filler tray (add to box inverted)
- Tray 2 - game summary tiles, first player marker, and soloist cards
- Tray 3 - money
- Tray 4 - memory and opus cards
- Tray 5a - period bonus tiles
- Tray 5b - royal court and city tiles
- Tray 6 - composer portrait & composer tiles
- Tray 7a, b, c, d - player pieces and cards
- Tray 7e - mozarts journey marker, and constanze cards & counters
- Tray 8 - story point counters