

FS-CTA Insert compatible with Call to Adventure®



Assembly Instructions

The package contains 5 sheets: two double and one single sheet.
After assembly the trays are put in up to three layers in the original game box.
Ordinary PVA glue is required when assembling each tray.
Please make sure you dry-assemble each tray correctly before gluing it together.
Please check www.foldedspace.net for general assembly tips.
As this is a colour print insert, please check www.foldedspace.com for detailed pictures to see how each trays pieces should be orientated.

FS-CTA

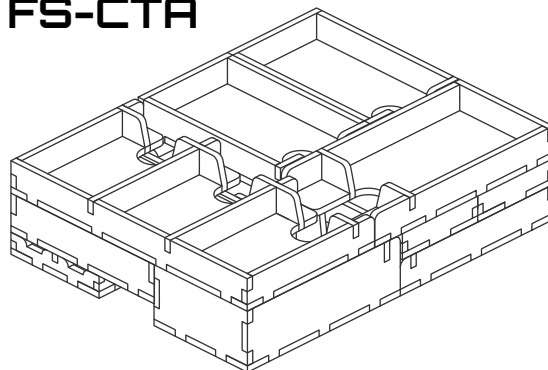

Tray 1

Sheet B1, B2

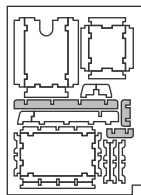

Step 1

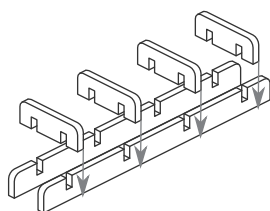

Finished tray

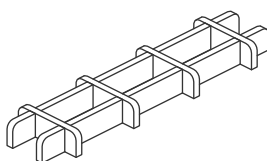

Sheet A1, A2

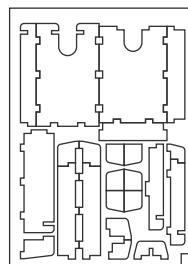

Sheet B1, B2

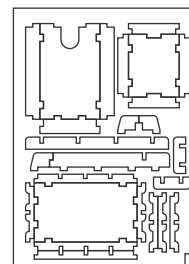

Sheet C

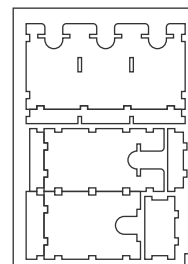

Tray 2a, 2b

(the trays are identical)

Sheet B1, B2

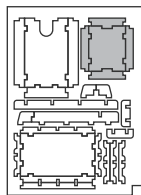

Step 1

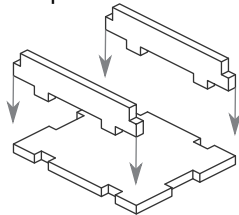

Step 2

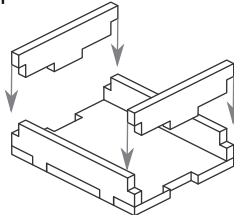

Finished tray

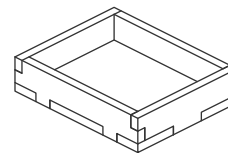

Tray 3a, 3b

(the trays are identical)

Sheet B1, B2

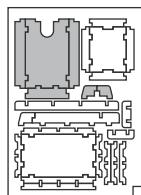

Step 1

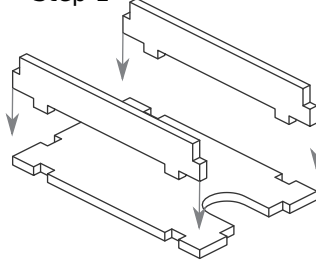

Step 2

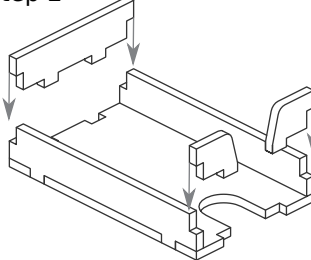

Finished tray

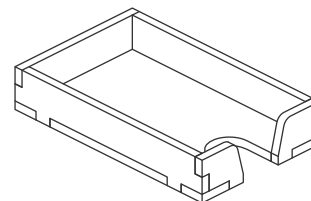

Tray 4

Sheet B1, B2

Sheet C

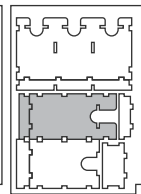
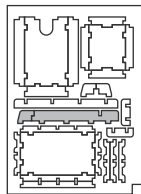

Step 1

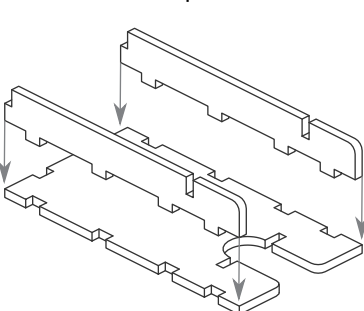

Step 2

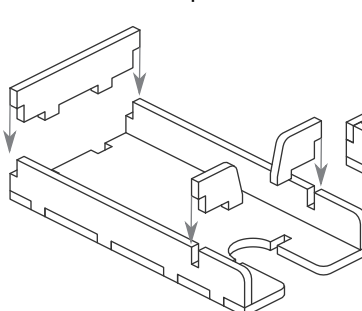

Finished tray

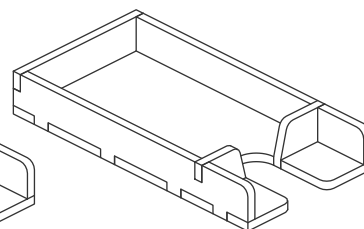

Tray 5a, 5b, 5c

(the trays are identical)

Sheet A1, A2 Sheet C

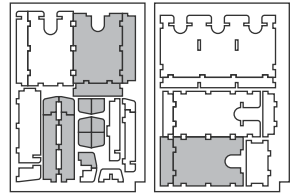

Step 1

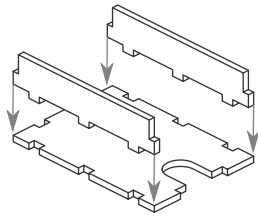

Step 2

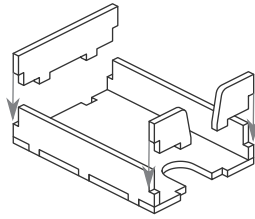

Step 3

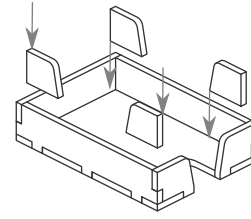

Finished tray

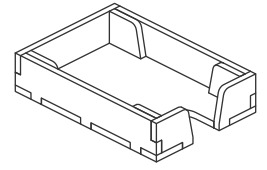

Tray 6a, 6b

Sheet A1, A2 Sheet C

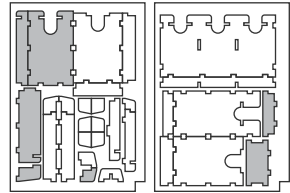

Step 1

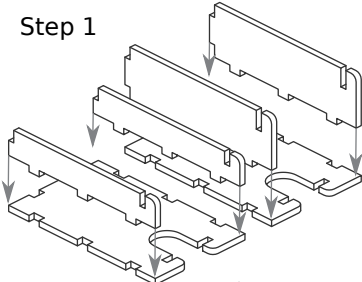

Step 2

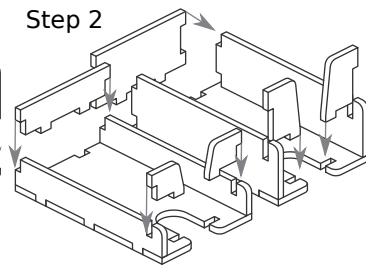

Finished trays

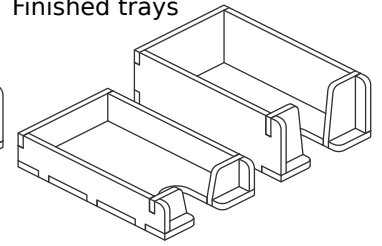

Tray 7

Sheet A1, A2 Sheet C

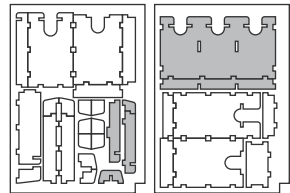

Step 1

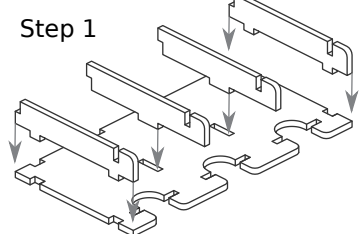

Step 2

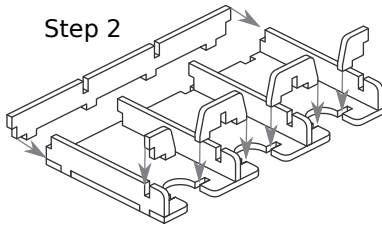

Finished tray

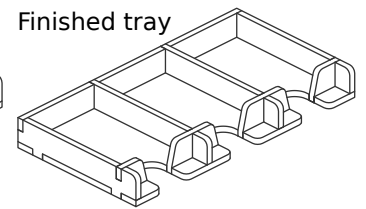

Tray 8a, 8b

(the trays are identical)

Sheet B1, B2

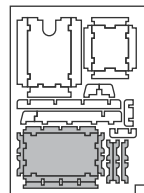

Step 1

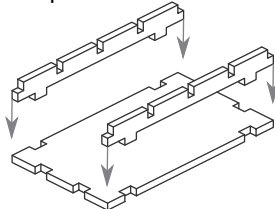

Step 2

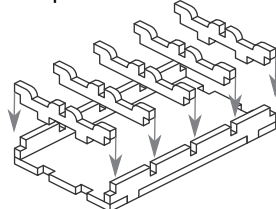

Step 3

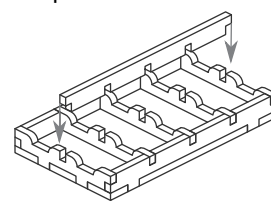

Finished tray

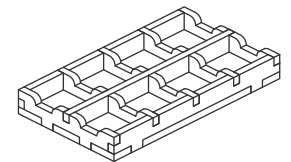

FS-CTA

Tray 3a, 3b
Tray 7

Tray 4

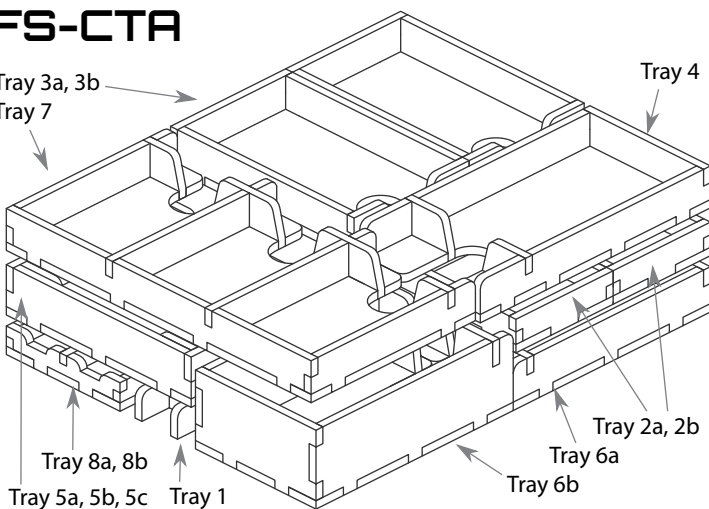

Tray 8a, 8b

Tray 5a, 5b, 5c

Tray 1

Tray 2a, 2b

Tray 6a

Please check www.foldedspace.com for photos of this insert in use.

Tray legend:

- Tray 1 - filler tray
- Tray 2a - experience tokens
- Tray 2b - name tokens & hero markers
- Tray 3a, b - bronze and silver character cards
- Tray 4 - gold character cards
- Tray 5a, b, c - story decks
- Tray 6a, b - expansion cards & score sheet
- Tray 7 - hero, anti-hero and solo cards
- Tray 8a, b - rune stones