

FS-RMGT insert

compatible with Rallyman GT®,

incl. the Championship®, Team Challenge®, World Tour®, GT4®, GT5®, and Adrenaline Pack® expansions



Assembly Instructions

The package contains 3 sheets, two identical and one different sheet.

After assembly the trays are put in three layers in the original game box.

Ordinary PVA glue is required when assembling each tray.

Please make sure you dry-assemble each tray correctly before gluing it together.

Please check www.foldedspace.com for general assembly tips.

Important: FS-RMGT includes two separate card tuck boxes for storing the hexagon track tiles that don't fit into the game box with the insert. Please check our website for details of how to assemble the tuck boxes.

FS-RMGT

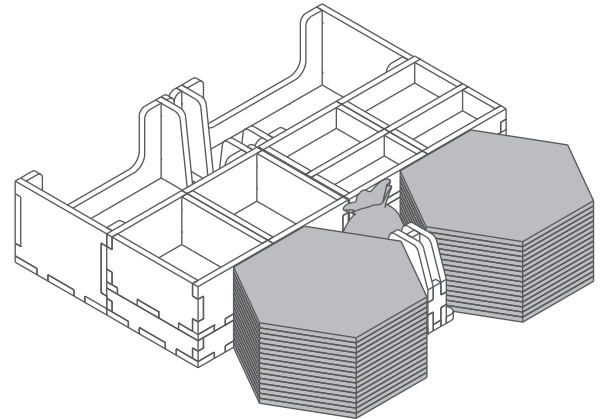

Sheet A1

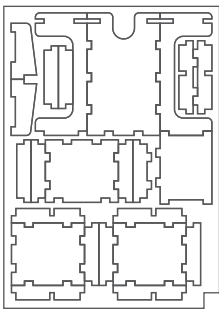

Sheet A2

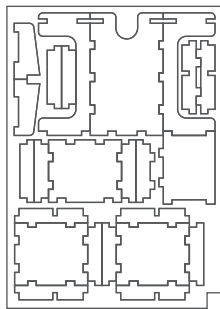

Sheet B1

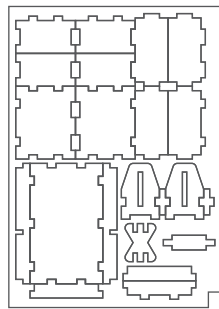

Tray 1a & 1b (the trays are identical)

Sheet A1

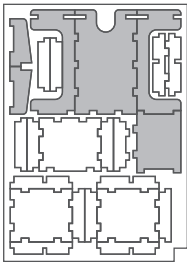

Sheet A2

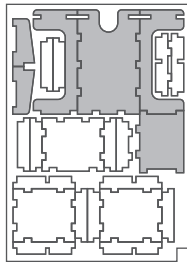

Step 1

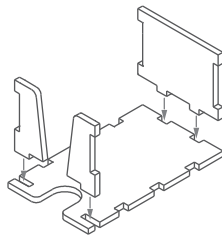

Step 2

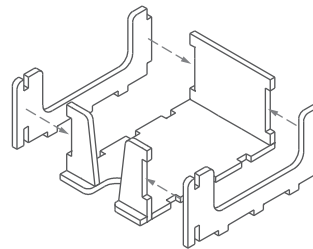

Finished tray

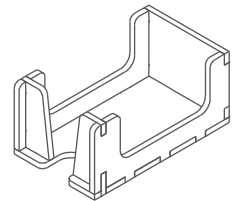

Tray 2a, 2b, 2c & 2d (the trays are identical)

Sheet A1

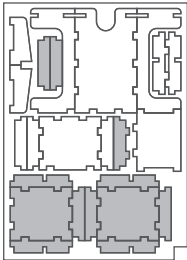

Sheet A2

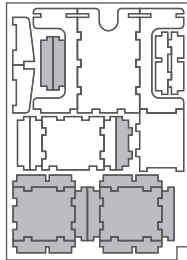

Step 1

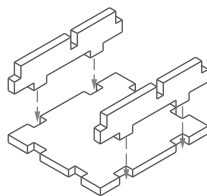

Step 2

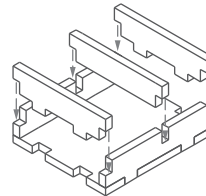

Finished tray

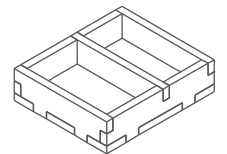

Tray 3a & 3b (the trays are same size as Tray 2a, b, c, d)

Sheet A1

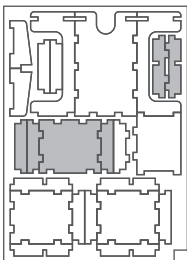

Sheet A2

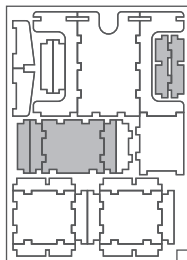

Step 1

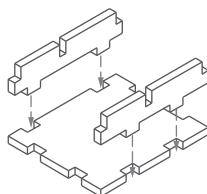

Step 2

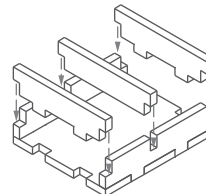

Finished tray

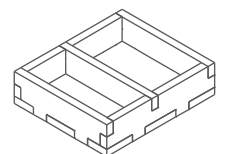

Tray 4a & 4b (the trays are identical)

Sheet B1

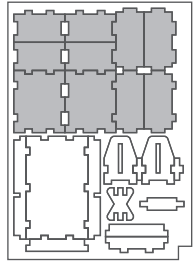

Step 1

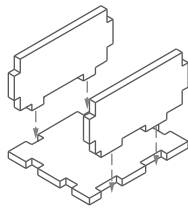

Step 2

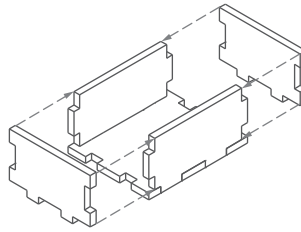

Finished tray

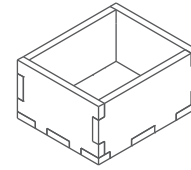

Tray 5

Sheet B1

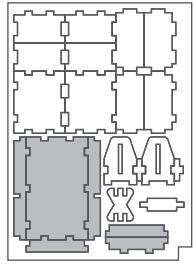

Step 1

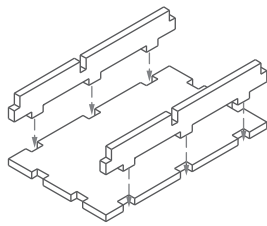

Step 2

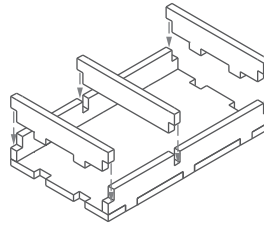

Finished tray

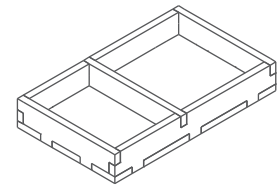

Tray 6

Sheet B1

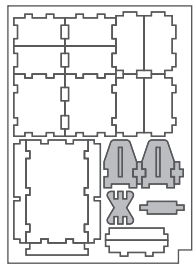

Step 1

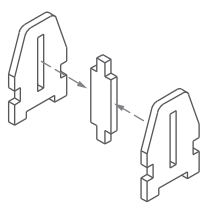

Step 2

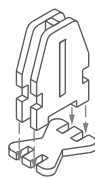

Step 3

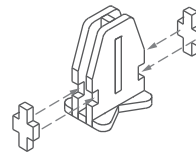

Finished tray

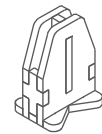

FS-RMGT

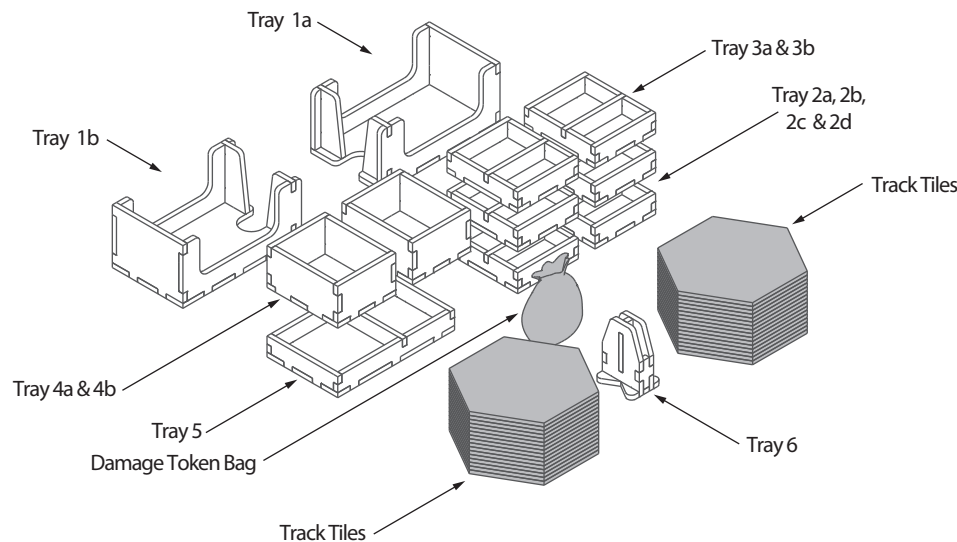

Please check www.foldedspace.com for photos of this insert in use.

Tray legend:

- Tray 1a, b - dashboard, driver and gaming aid cards
- Tray 2a, b, c, d - player pieces
- Tray 3a, b - player pieces
- Tray 4a, b - focus tokens, up to 100 tokens in each tray
- Tray 5 - dice, round markers, oil & debris tokens, and sisu tokens
- Tray 6 - filler tray

Note: the damage tokens are stored in the damage token bag, and this is placed as shown between the two stacks of track tiles. Each stack of track tiles is 24 tiles high. You can optionally swap 14 tiles on one side for the Adrenaline Pack bridge together with its base. The remaining track tiles should be stored separately in the card tuck boxes provided.