

FS-RMDIRT Insert compatible with Rallyman: DIRT®, including the Rx, R4, R5, Co-Pilot Pack, Climb, and 110% expansions



Assembly Instructions

The package contains 6 sheets: two double and two single sheets.
After assembly the trays are put in up to three layers in the original game box.
Ordinary PVA glue is required when assembling each tray.
Please make sure you dry-assemble each tray correctly before gluing it together.

Important: FS-RMDIRT includes two separate card tuck boxes for storing the hexagon track tiles, which don't fit into the game box with the insert. Please check our website for details of how to assemble the tuck boxes.

FS-RMDIRT

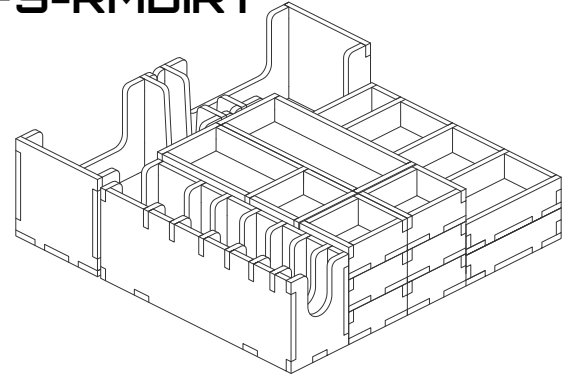

Sheet A1, A2 Sheet B1, B2 Sheet C Sheet D

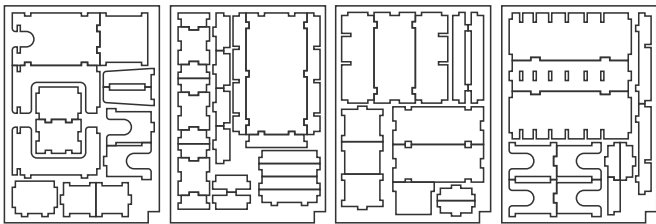

Tray 1a-1f

Sheet B1, B2

(the six trays are identical)

Step 1

Step 2

Finished tray

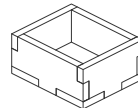
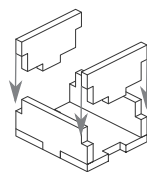
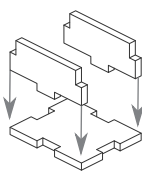
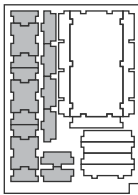

Tray 2a, 2b

Sheet A1, A2

(the trays are identical)

Step 1

Step 2

Finished tray

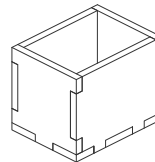
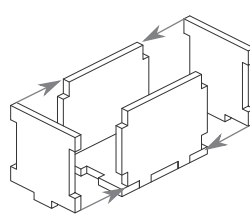
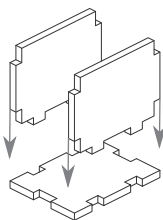
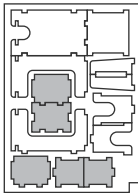

Tray 3

Sheet C

Step 1

Step 2

Finished tray

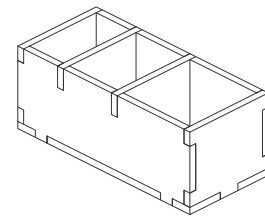
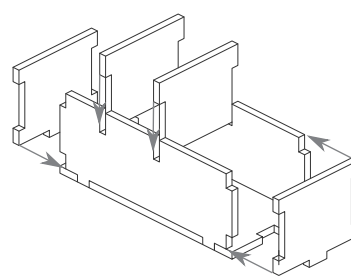
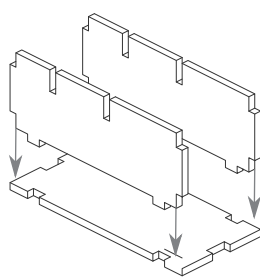
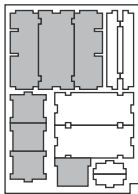

Tray 4a, 4b

Sheet C

Sheet D

Step 1

Step 2

Finished tray

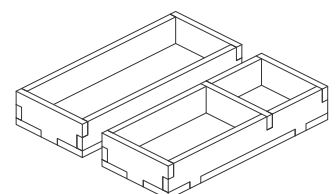
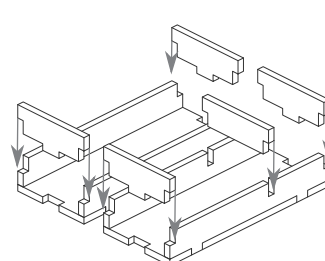
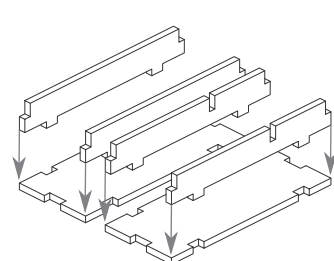
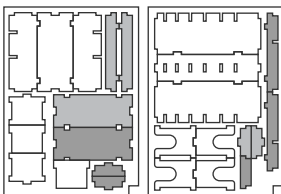

FS-RMDIRT Insert compatible with Rallyman: DIRT®, including the Rx, R4, R5, Co-Pilot Pack, Climb, and 110% expansions



Tray 5a, 5b

Sheet A1, A2

(the trays are identical)

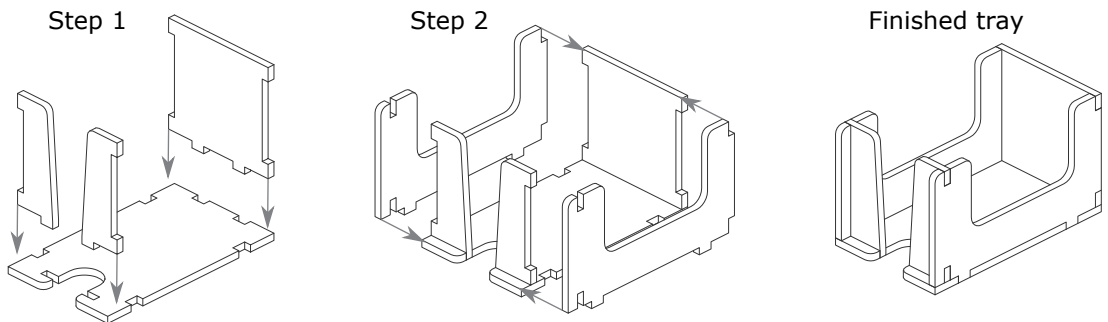

Tray 6a, 6b

Sheet B1, B2

(the trays are identical)

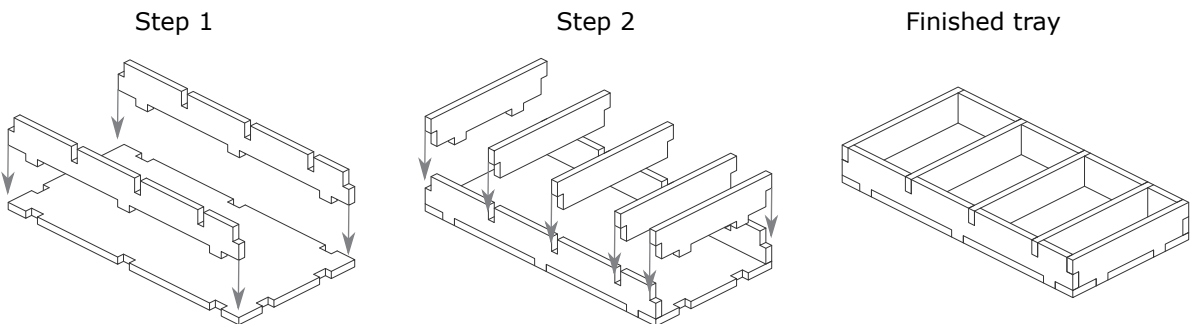

Tray 7

Sheet A1, A2 Sheet D

Step 1

Step 2

Finished tray

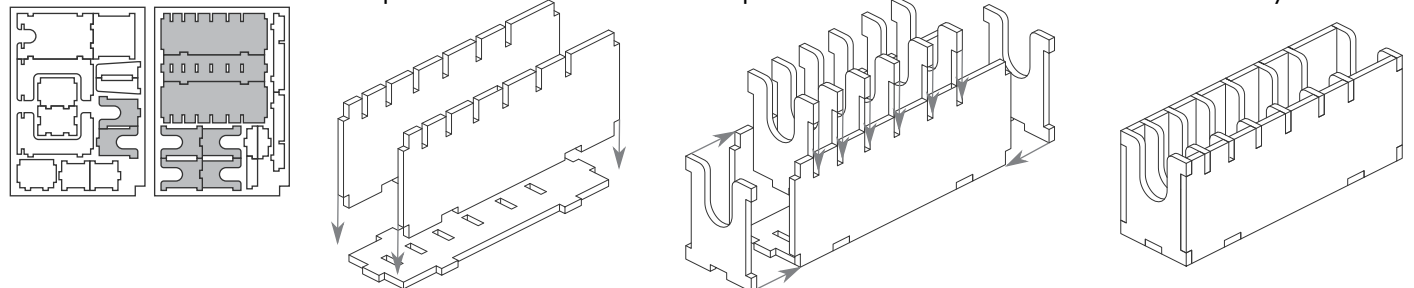

FS-RMDIRT

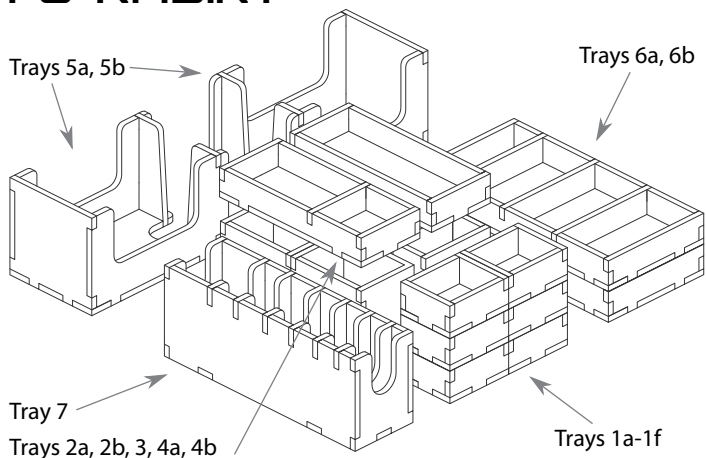

Tray legend:

- Tray 1a, b, c, d, e, f - player tokens and cars
- Tray 2a - focus tokens
- Tray 2b - damage tokens
- Tray 3 - second tokens
- Tray 4a - dice
- Tray 4b - arch standees & round marker, and jump, water hazard & chicane tokens
- Tray 5a, b - dashboard and driver cards
- Tray 6a - gear or boost/brake/coast dashboard tokens, and grey cloud, oxygen & climb tokens
- Tray 6b - other damage tokens, set-up tokens, and coast/brake/boost & track type/sisu/puncture proof dashboard tokens
- Tray 7 - time cards, and the six player spare tire cards

Note: the damage tokens are stored in two trays. The ones in use for current games are stored in Tray 2b, and then Tray 6b has a slot for other damage tokens from expansions not currently in use.

Please check www.foldedspace.com for photos of this insert in use.