

# FS-BTKU Insert compatible with Bitoku



## Assembly Instructions

The package contains 4 sheets: one double and two single sheets.

After assembly the trays are put in up to two layers in the original game box.

Ordinary PVA glue is required when assembling each tray.

Please make sure you dry-assemble each tray correctly before gluing it together.

FS-BTKU is a colour insert, please check our website for images of ready trays so that you can see how to correctly orientate the tray pieces.

### FS-BTKU

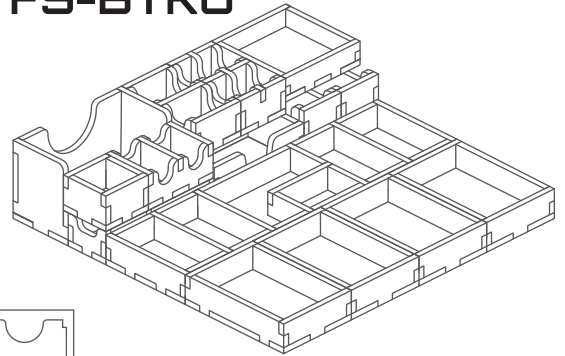

Sheet A1

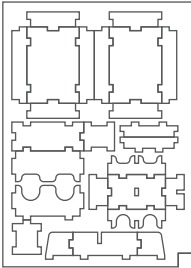

Sheet A2

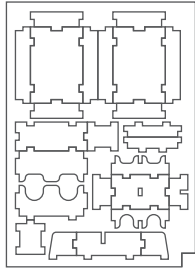

Sheet B

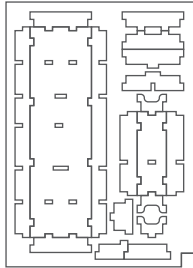

Sheet C

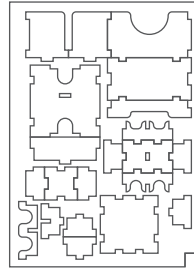

### Tray 1

Sheet C

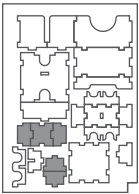

Step 1

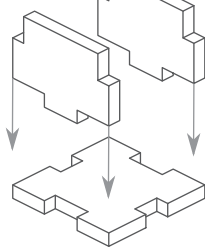

Step 2

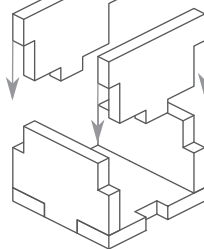

Finished tray

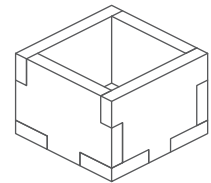

### Tray 2

Sheet A1, A2 Sheet C

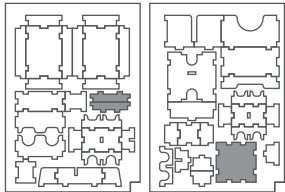

Step 1

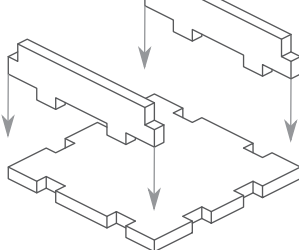

Step 2

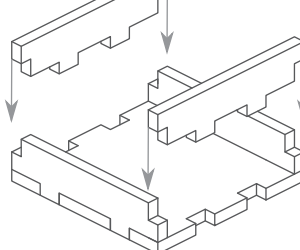

Finished tray

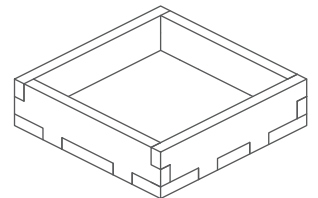

### Tray 3

Sheet B

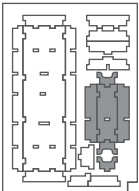

Step 1

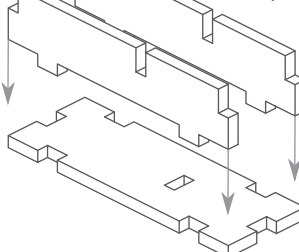

Step 2

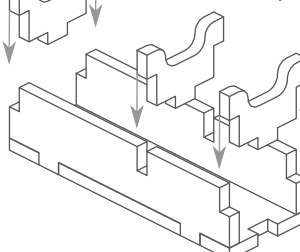

Finished tray

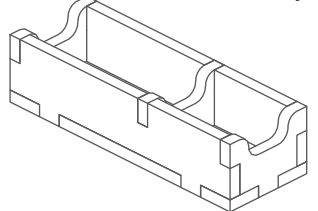

### Tray 4a, 4b, 4c, 4d (the trays are identical)

Sheet A1, A2

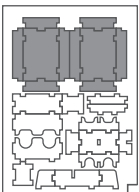

Step 1

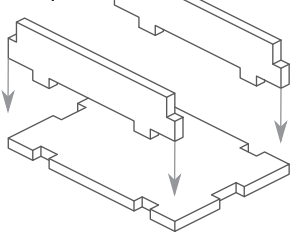

Step 2

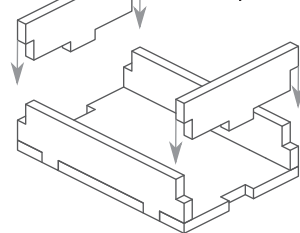

Finished tray

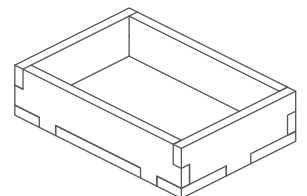

## Tray 5a, 5b

(the trays are identical)

Sheet A1, A2

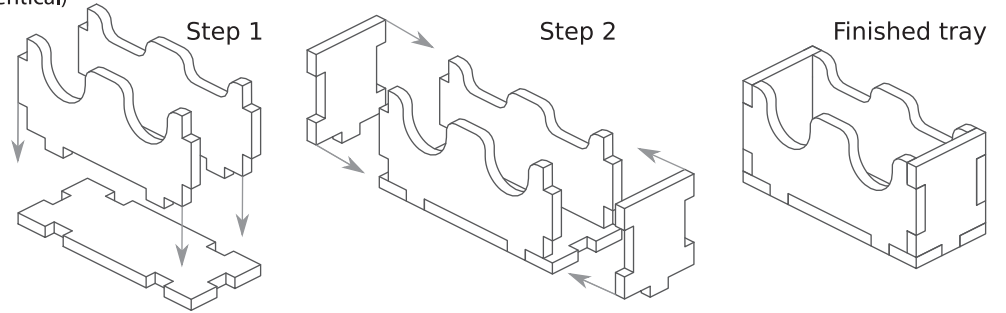
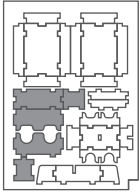

## Tray 6a, 6b

Sheet A1, A2 Sheet B

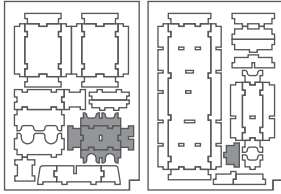

Sheet C

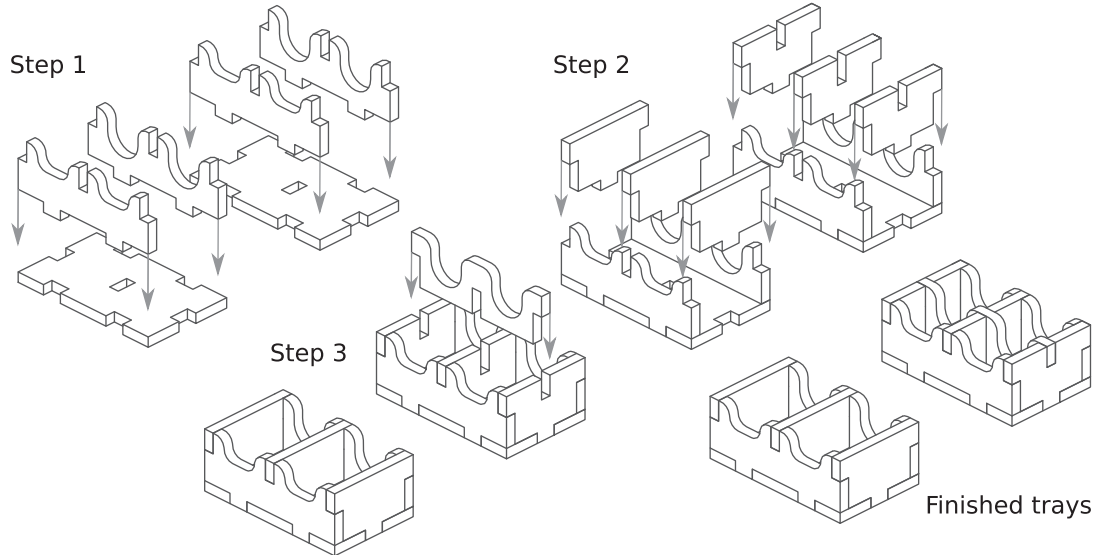
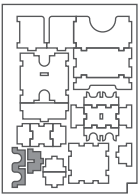

## Tray 7

Sheet C

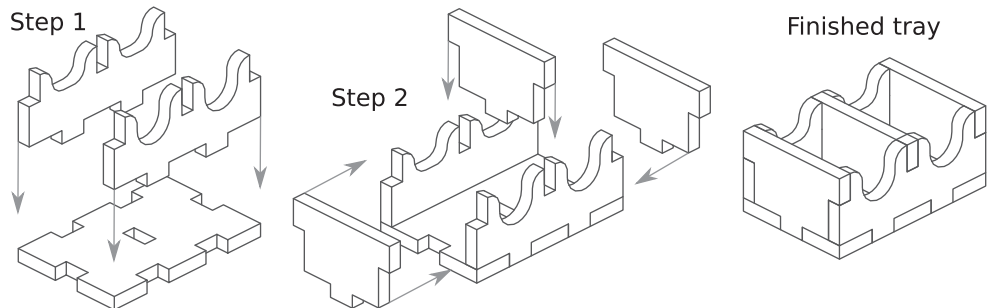
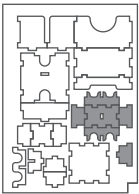

## Tray 8

Sheet C

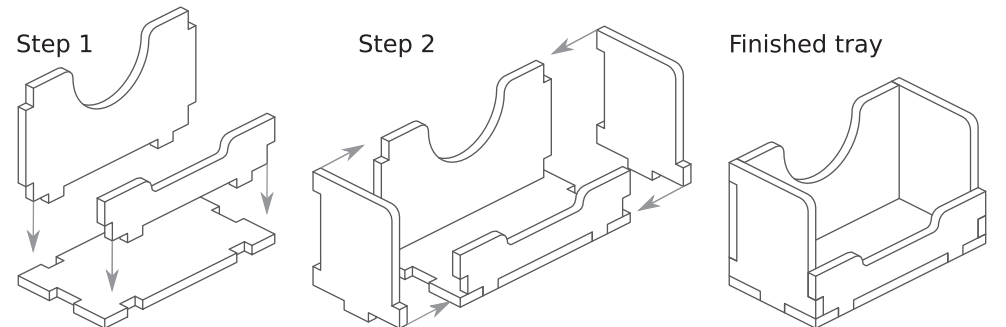
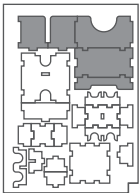

## Tray 9

Sheet A1, A2 Sheet C

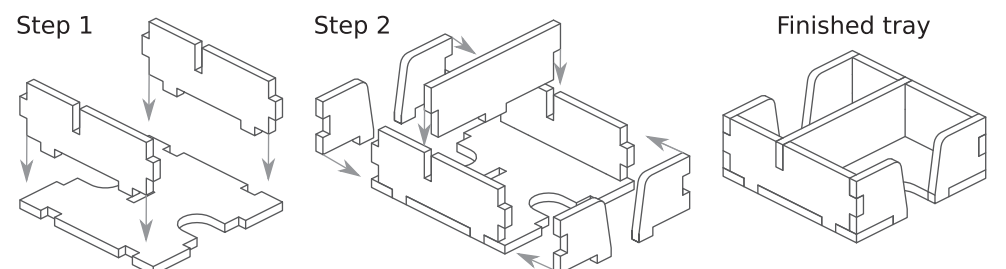
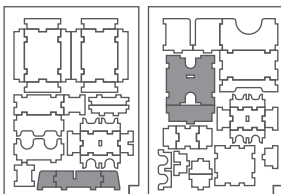

## Tray 10

Sheet B

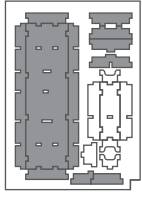

Step 1

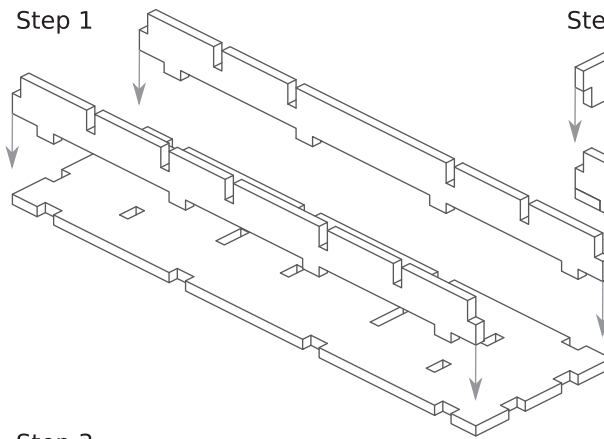

Step 2

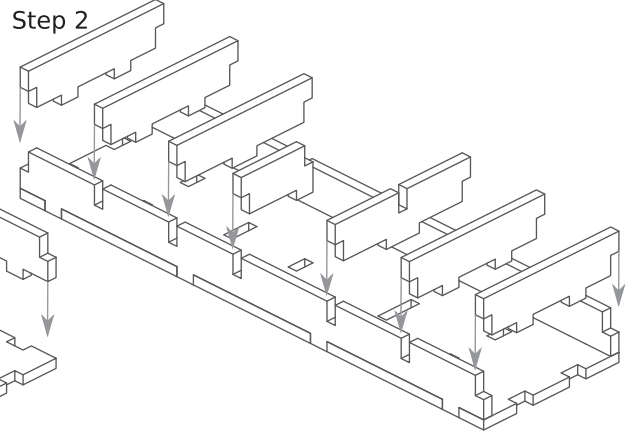

Step 3

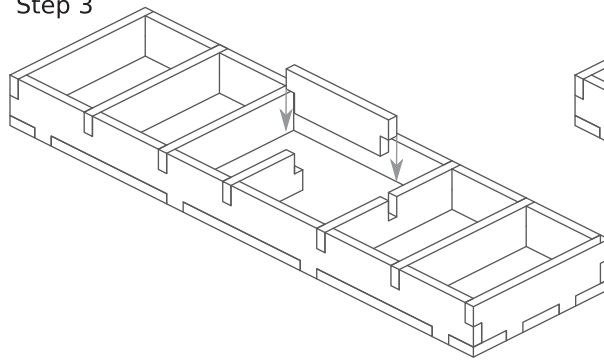

Finished tray

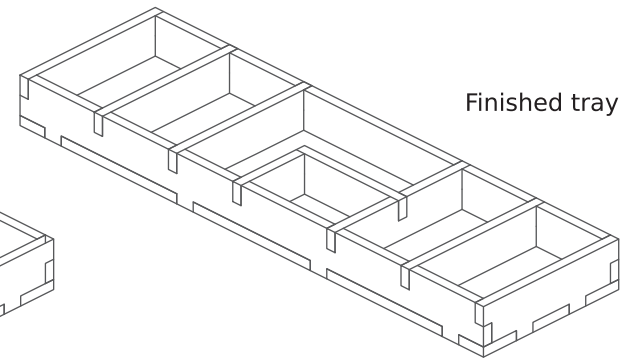

## FS-BTKU

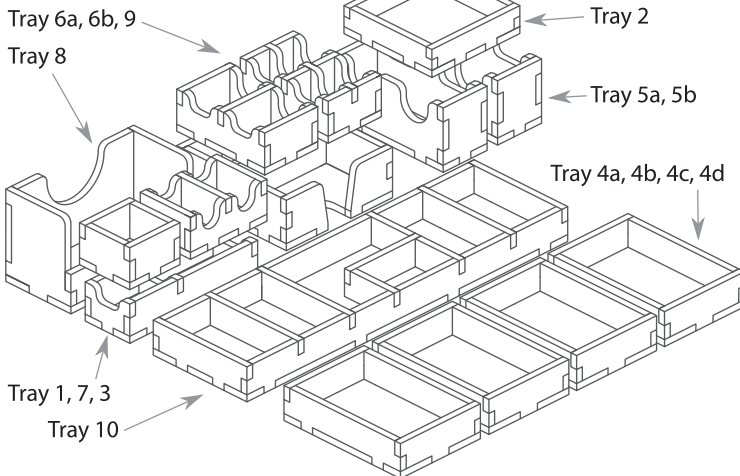

Please check [www.foldedspace.net](http://www.foldedspace.net) for photos of this insert in use.

### Tray legend:

- Tray 1 - iwakura rock tiles
- Tray 2 - great spirit & pagoda counters
- Tray 3 - +2 & +3 amulet tokens
- Tray 4a, b, c, d - player pieces
- Tray 5a - building tiles
- Tray 5b - ancient building & gate tiles
- Tray 6a - dragonfly tiles
- Tray 6b - mitama spirit tiles
- Tray 7 - crystal tiles
- Tray 8 - medium sized cards
- Tray 9 - small cards and main board inserts & lake treasure tiles
- Tray 10 - resources, +1 amulets, and hikaru markers

### Note:

FS-BTKU is a full print insert. This means that the orientation of the tray pieces is important as in some cases the print on each side of a piece is different. Most trays are very straight-forward as to which way round each piece should go, but in order to prevent possible errors we strongly recommend checking our FS-BTKU product page on [www.foldedspace.net](http://www.foldedspace.net) so that you can see images of the fully assembled trays. In general, all the printed kodama spirits should be placed on the outside of the trays.

We always recommend dry-building the trays before adding glue, but for such full colour print designs this is even more important so that you can be sure everything is correct before gluing the tray pieces in place.