

FS-TARGI insert compatible with TARGI®, incl. Targi: The Expansion® expansion

Assembly Instructions

The package contains 2 sheets, both of them are identical.

The parts marked in sheet A2 are to be discarded.

After assembly the trays are put in two layers in the original game box.

Ordinary PVA glue is required when assembling each tray.

Please make sure you dry-assemble each tray correctly before gluing it together.

Please check www.foldedspace.net for general assembly tips.

FS-TARGI

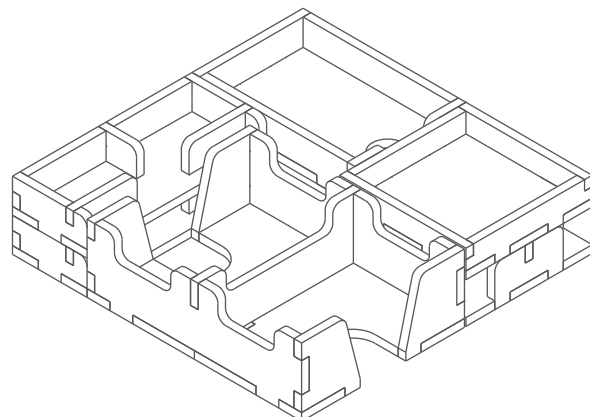

Sheet A1

Sheet A2

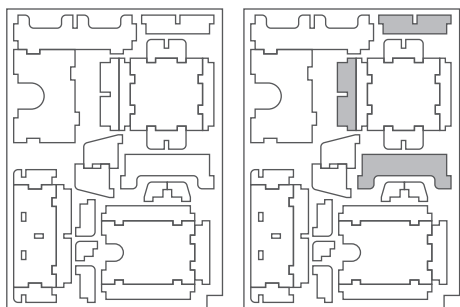

Tray 1

Sheet A1

Sheet A2

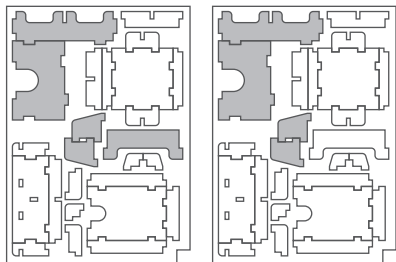

Step 1

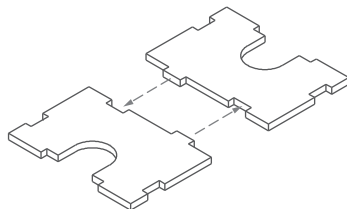

Step 2

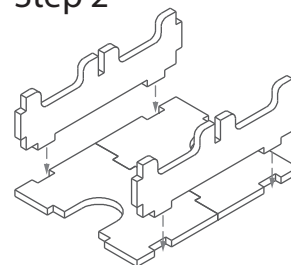

Step 3

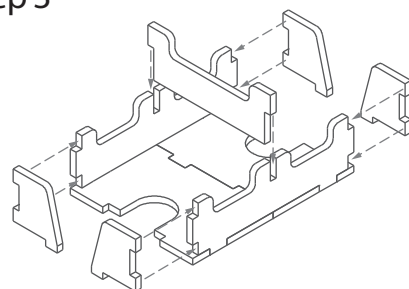

Finished tray

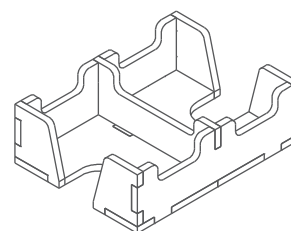

Tray 2

Sheet A1

Sheet A2

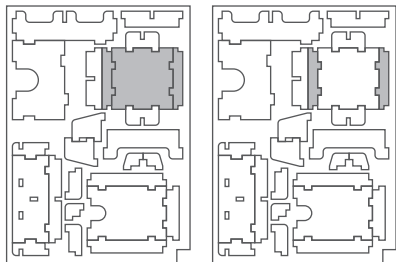

Step 1

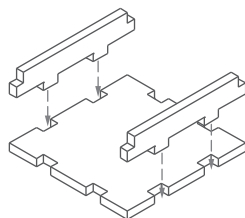

Step 2

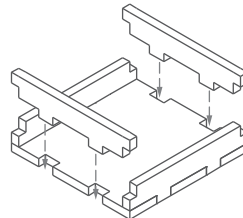

Finished tray

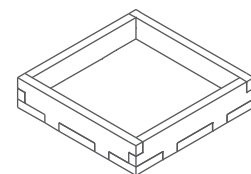

Tray 3a & 3b (the trays are identical)

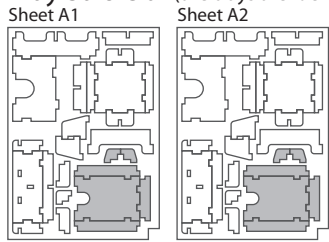

Step 1

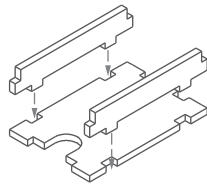

Step 2

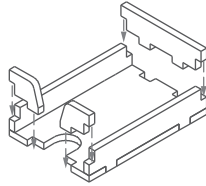

Finished tray

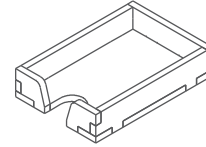

Tray 4a & 4b (the trays are identical)

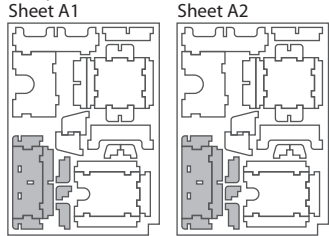

Step 1

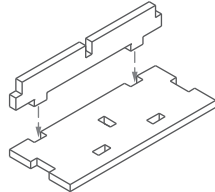

Step 2

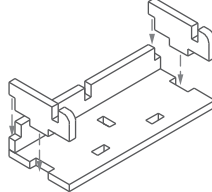

Step 3

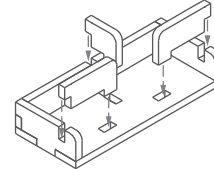

Finished tray

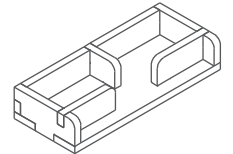

Tray 5

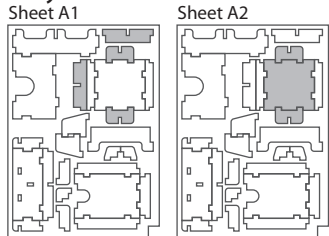

Step 1

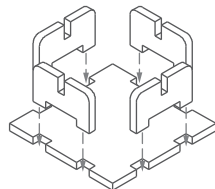

Step 2

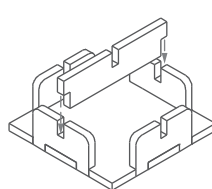

Step 3

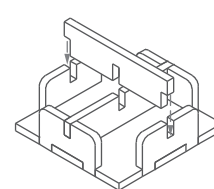

Finished tray

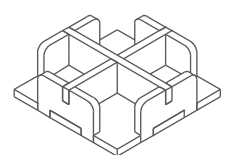

FS-TARGI

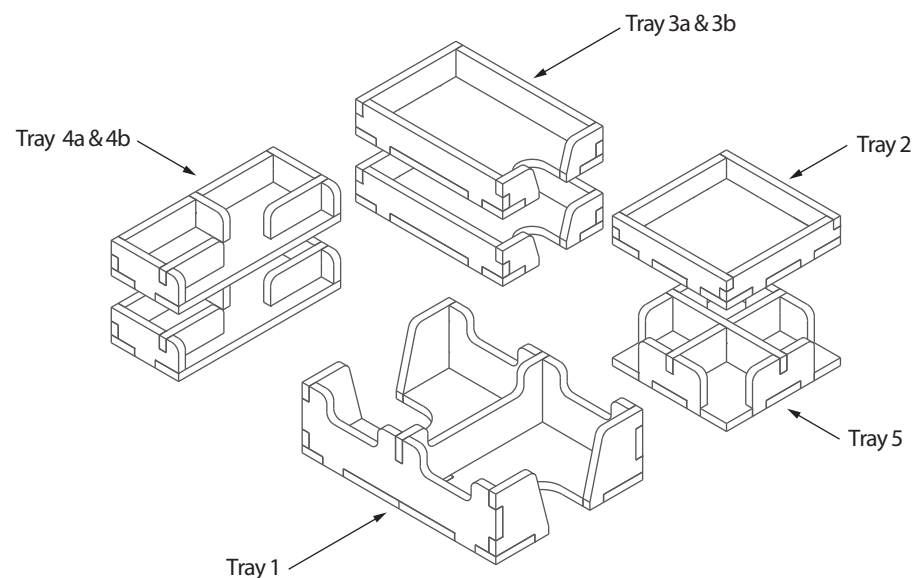

Please check www.foldedspace.net for photos of this insert in use.

Tray legend:

- Tray 1 - tribe and border cards
- Tray 2 - targia figure, starting player token, action markers, and wooden player pieces
- Tray 3a - goods cards
- Tray 3b - sand dune cards
- Tray 4a - water and salt tokens
- Tray 4b - date and pepper tokens
- Tray 5 - gold and victory point tokens