

# FS-IMPv2 insert

compatible with Empires of the North<sup>®</sup>,

incl. Barbarian Hordes<sup>®</sup>, Roman Banners<sup>®</sup>, and Japanese Islands<sup>®</sup> expansions

Separately compatible with Imperial Settlers<sup>®</sup> and 51st State: Master Set<sup>®</sup> games



## Assembly Instructions

The package contains 4 sheets, two of them are identical to the other two.

The parts marked in sheet B2 are to be discarded.

After assembly the trays are put in three layers in the original game box.

Ordinary PVA glue is required when assembling each tray.

Please make sure you dry-assemble each tray correctly before gluing it together.

Please check [www.foldedspace.net](http://www.foldedspace.net) for general assembly tips.

## FS-IMPv2

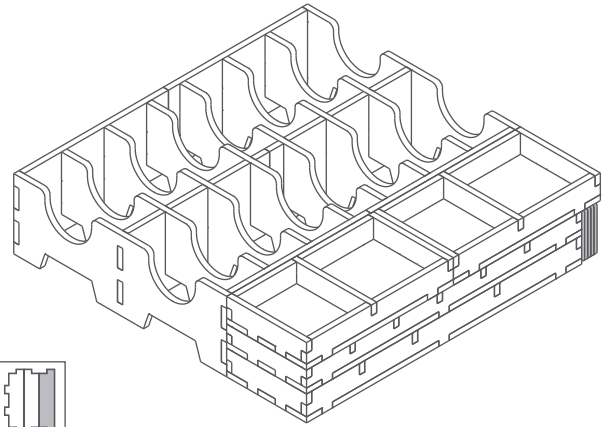

Sheet A1

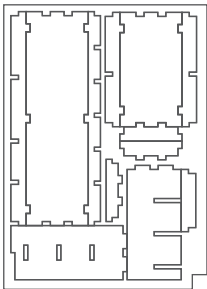

Sheet A2

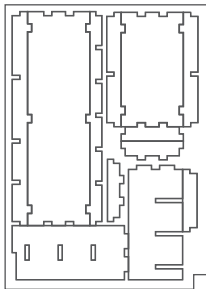

Sheet B1

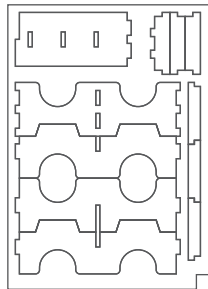

Sheet B2

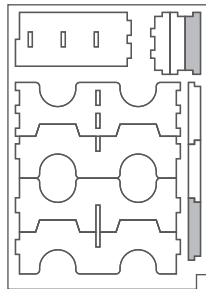

### Tray 1a & 1b

(the trays are identical)

Sheet A1, A2

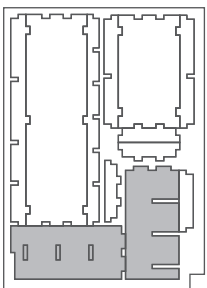

Sheet B1, B2

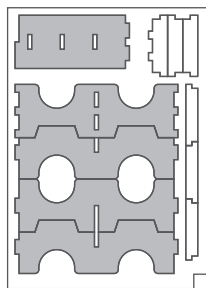

Step 1

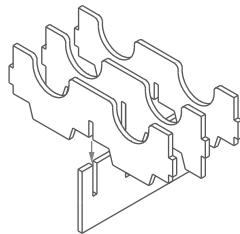

Step 2

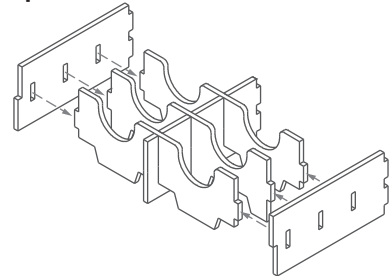

Step 3

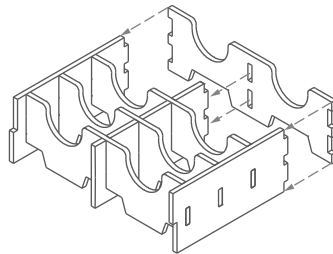

Finished tray

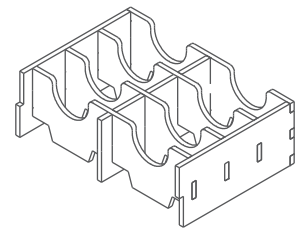

### Tray 2a & 2b

(the trays are identical)

Sheet A1

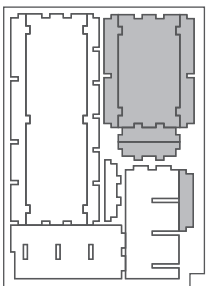

Sheet A2

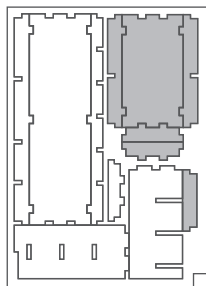

Step 1

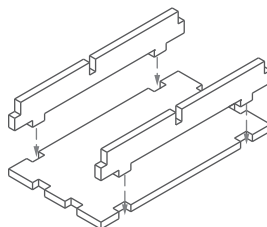

Step 2

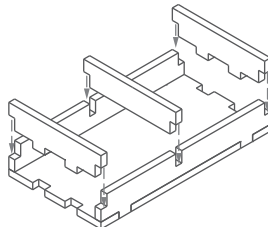

Finished tray

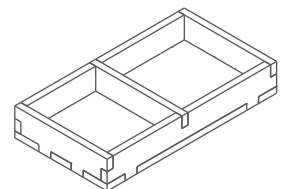

# FS-IMPv2 insert compatible with Empires of the North<sup>®</sup>,

incl. Barbarian Hordes<sup>®</sup>, Roman Banners<sup>®</sup>, and Japanese Islands<sup>®</sup> expansions  
 Separately compatible with Imperial Settlers<sup>®</sup> and 51st State: Master Set<sup>®</sup> games



## Tray 3

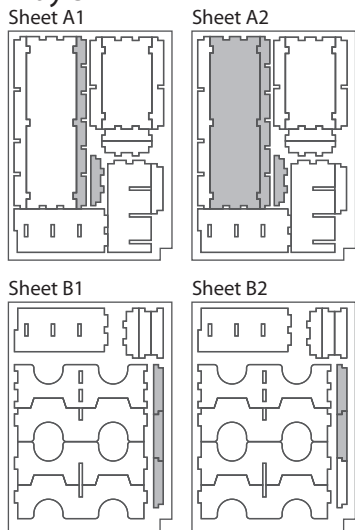

Step 1

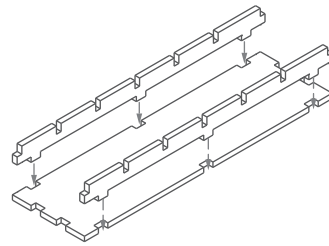

Step 2

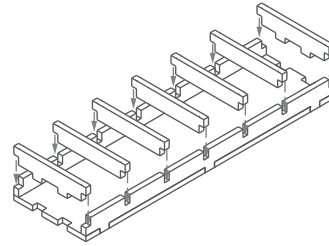

Finished tray

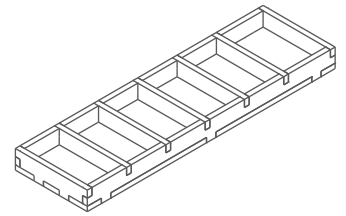

## Tray 4

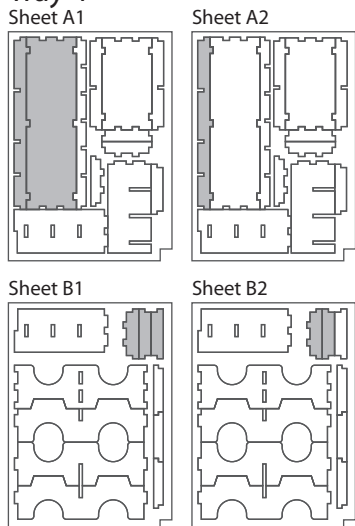

Step 1

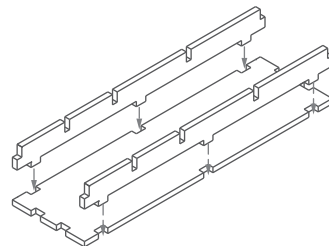

Step 2

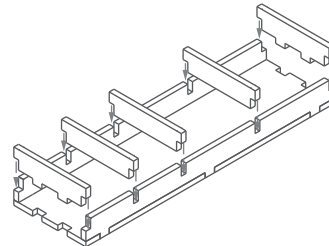

Finished tray

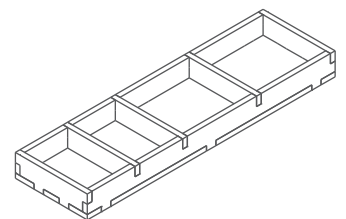

# FS-IMPv2

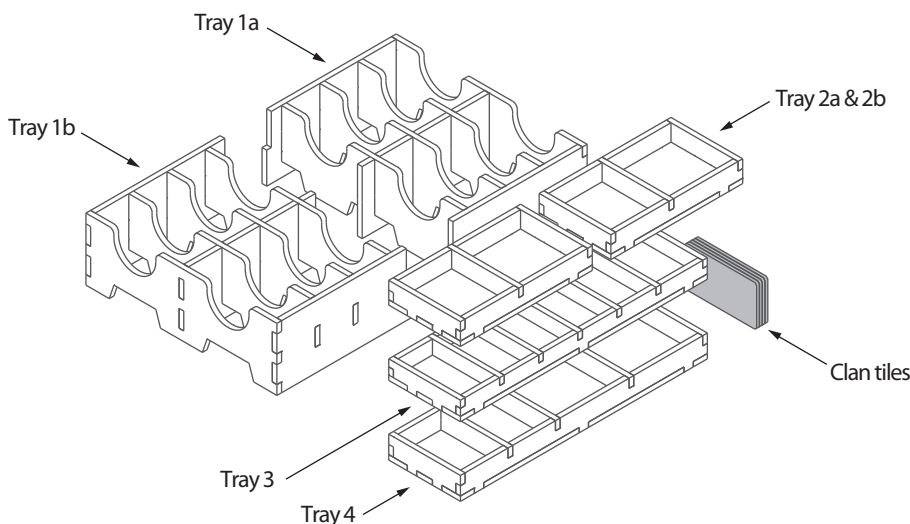

Please check [www.foldedspace.net](http://www.foldedspace.net) for photos of this insert in use.

### Tray legend:

- Tray 1a, b - game cards. Each large slot is sized to hold two sleeved clan decks. Place the two island card decks in the smaller central slots.
- Tray 2a - ship tokens
- Tray 2b - ship tokens and action tiles & st player marker
- Tray 3 - action pawns & number tokens, workers, sheep and gold tokens
- Tray 4 - fish, food, wood, stone, raze and multiplier tokens & clan score markers

Note: for details of how to use the trays when using the insert with Imperial Settlers or 51st State, please check our website for more info.