

FS-MARCH+ insert

compatible with Marvel Champions: The Rise of Red Skull®, with space for 725 sleeved or 1,150 unsleeved cards



Assembly Instructions

The package contains 2 sheets, each different from the other.

Ordinary PVA glue is required when assembling each tray.

Please make sure you dry-assemble each tray correctly before gluing it together.

Please check www.foldedspace.net for general assembly tips.

Note that the insert includes two bonus trays, not really needed for this kind of game. These can either be added as shown to the insert, or used separately for other purposes.

FS-MARCH+

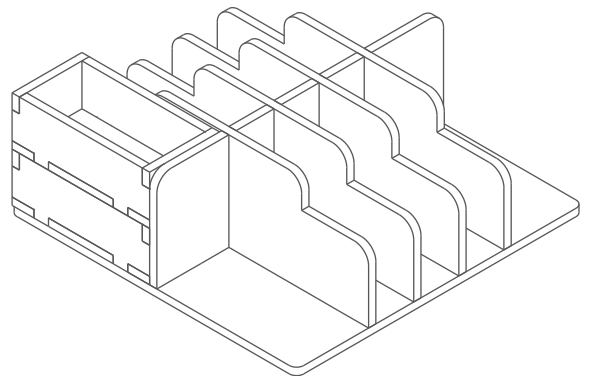

Sheet A1

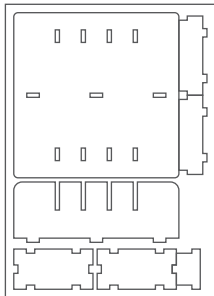

Sheet B1

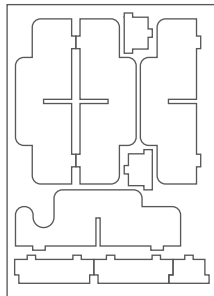

Tray 1a & 1b (the trays are identical)

Sheet A1

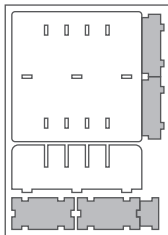

Sheet B1

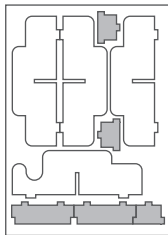

Step 1

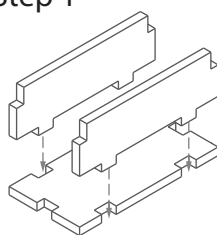

Step 2

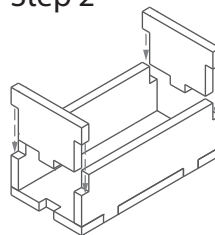

Finished tray

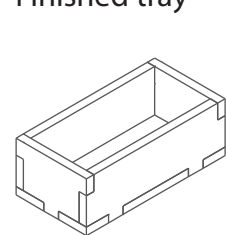

Tray 2

Sheet A1

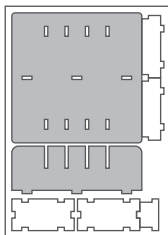

Sheet B1

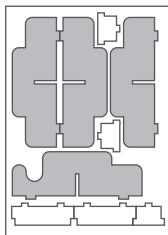

Step 1

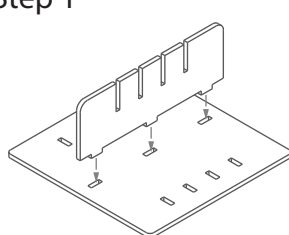

Step 2

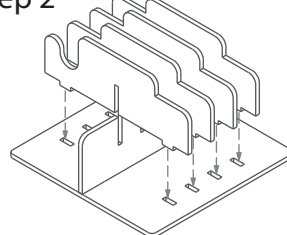

Finished tray

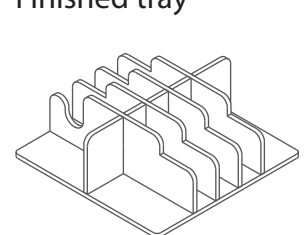

FS-MARCH+

Tray 1a & 1b →

Tray 2 →

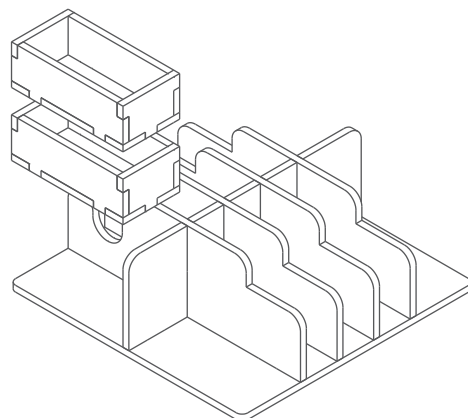

Tray legend:

Tray 1a, b - bonus trays

Tray 2 - main card tray. The six central slots are designed to store one sleeved hero deck each, with the larger slots being for scenario and campaign decks.

Please check www.foldedspace.net for photos of this insert in use.