

# FS-BPARK insert compatible with Barenpark®, incl. The Bad News Bears® expansion

## Assembly Instructions

The package contains 3 sheets, two identical and one different sheet.

After assembly the trays are put in three layers in the original game box.

Ordinary PVA glue is required when assembling each tray.

Please make sure you dry-assemble each tray correctly before gluing it together.

Please check [www.foldedspace.net](http://www.foldedspace.net) for general assembly tips.

## FS-BPARK

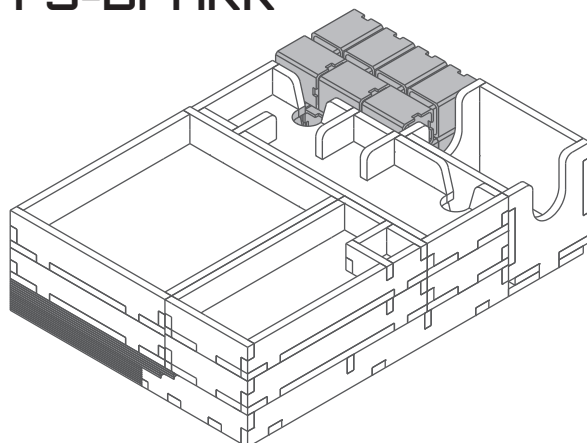

Sheet A1

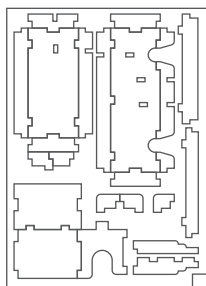

Sheet A2

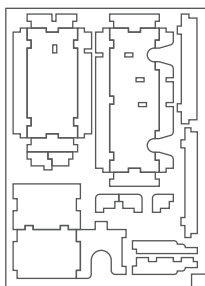

Sheet B1

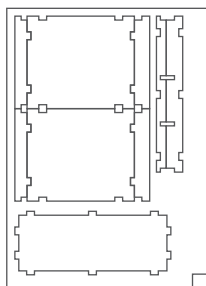

### Tray 1a & 1b (the trays are identical)

Sheet A1

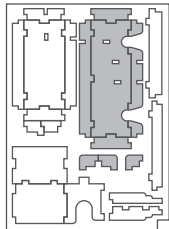

Sheet A2

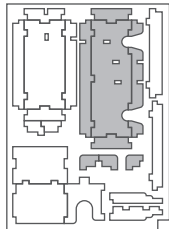

Step 1

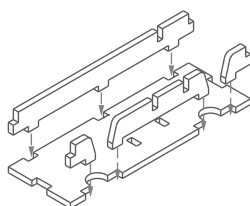

Step 2

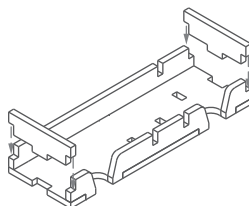

Step 3

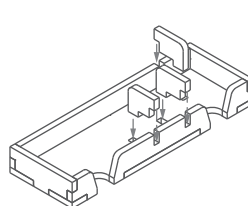

Finished tray

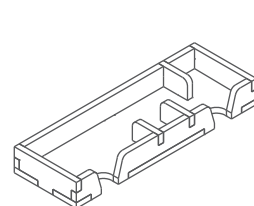

### Tray 2

Sheet A1

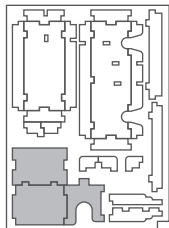

Sheet A2

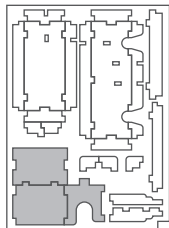

Step 1

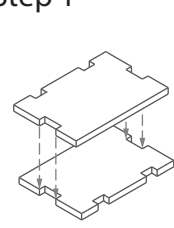

Step 2

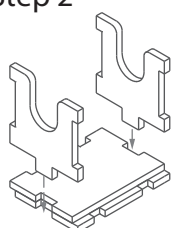

Step 3

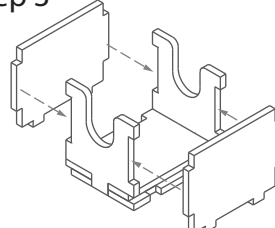

Finished tray

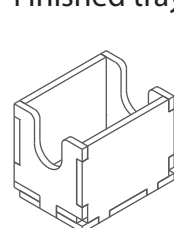

### Tray 3a & 3b (the trays are identical)

Sheet A1

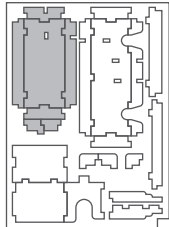

Sheet A2

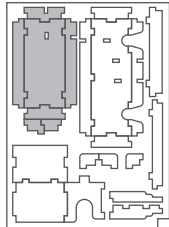

Step 1

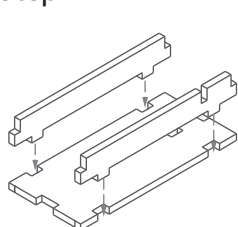

Step 2

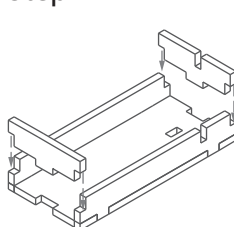

Step 3

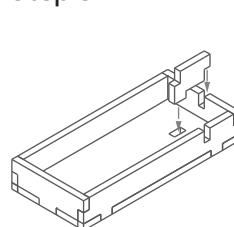

Step 4

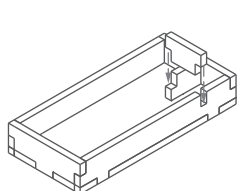

Finished tray

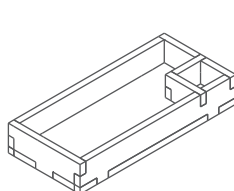

### Tray 4

Sheet A1, A2

Sheet B1

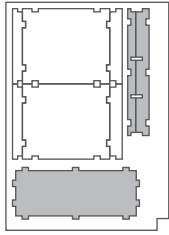
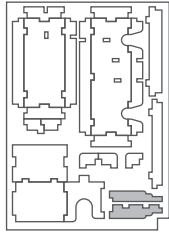

Step 1

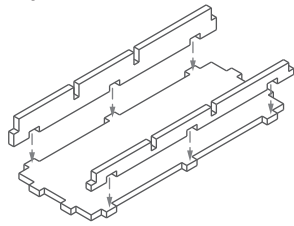

Step 2

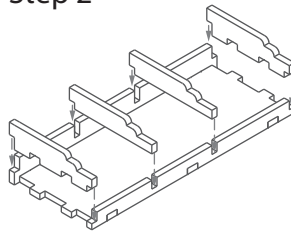

Finished tray

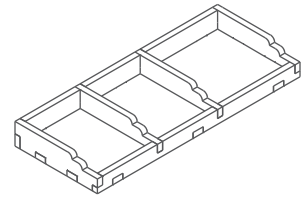

### Tray 5

Sheet A1, A2

Sheet B1

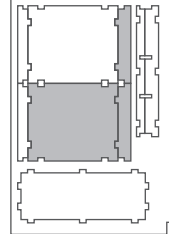
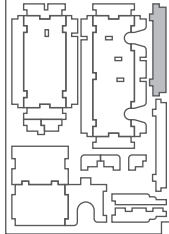

Step 1

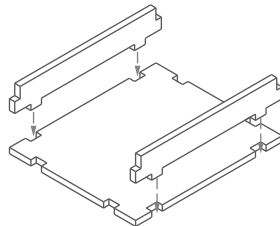

Step 2

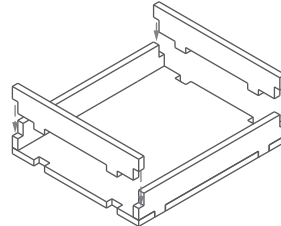

Finished tray

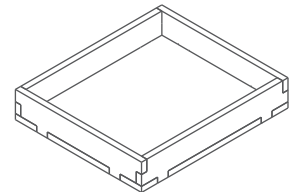

### Tray 6

Sheet A1, A2

Sheet B1

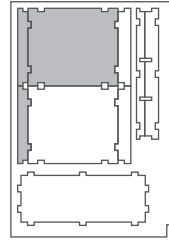
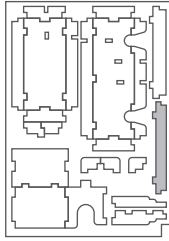

To assemble  
repeat steps  
of Tray 5.

Finished tray

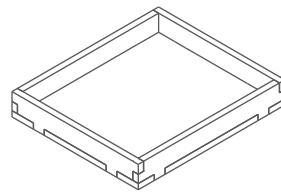

## FS-BPARK

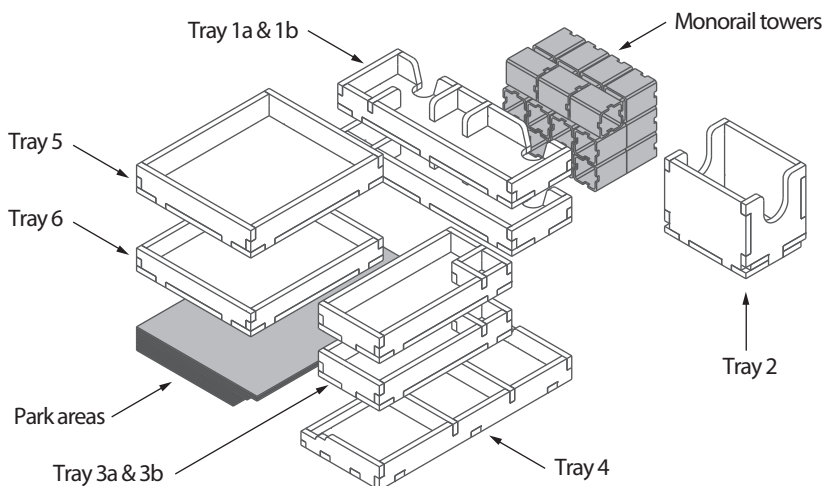

Please check [www.foldedspace.net](http://www.foldedspace.net) for photos of this insert in use.

### Tray legend:

- Tray 1a - rivers & food streets
- Tray 1b - playgrounds & five open flat monorail towers
- Tray 2 - achievement tiles
- Tray 3a, b - animal houses
- Tray 4 - toilets, bear statues, & monorail cars
- Tray 5 - grizzly habitats
- Tray 6 - animal enclosures

Note: the board and rule books go on top of the trays. Once the game box lid is added there will be 9 mm of lid lift. Check our website for photos showing how this works.