

FS-TEO insert
 compatible with Teotihuacan®,
 incl. Teotihuacan: Late Preclassic Period® expansion

Assembly Instructions

The package contains 4 sheets, two of them are identical to the other two.

The parts marked in sheet B2 are to be discarded.

After assembly the trays are put in two layers in the original game box.

Ordinary PVA glue is required when assembling each tray.

Please make sure you dry-assemble each tray correctly before gluing it together.

Please check www.foldedspace.net for general assembly tips.

FS-TEO

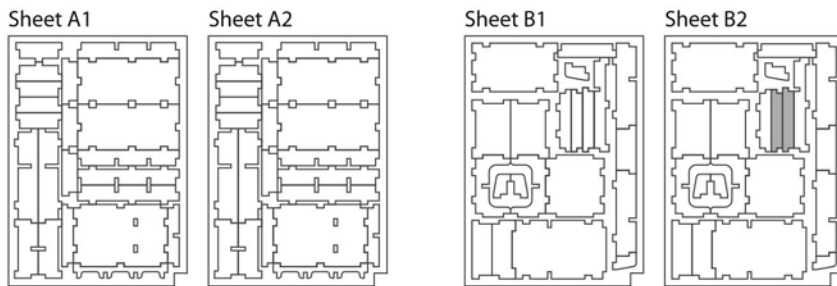
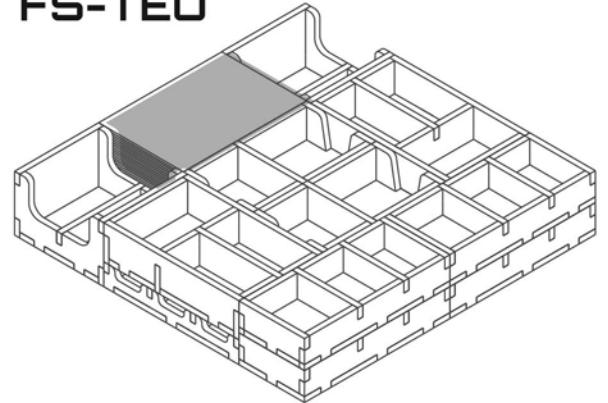

Tray 1a, 1b, 1c & 1d (the trays are identical)

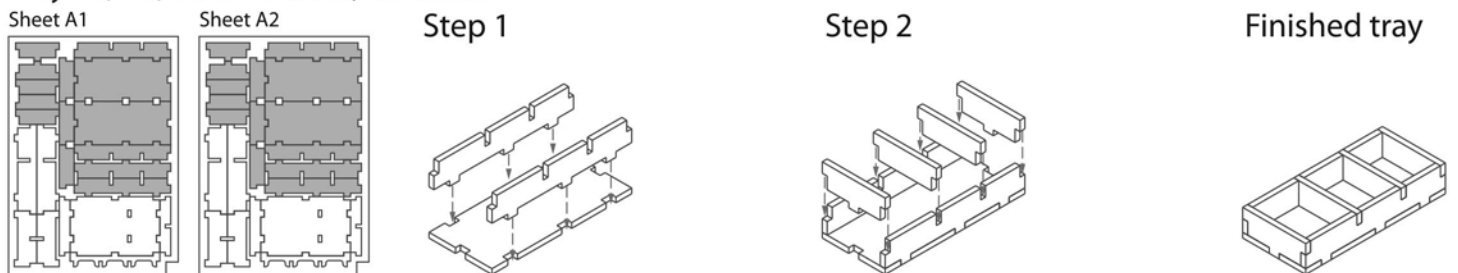

Tray 2a & 2b (the trays are identical)

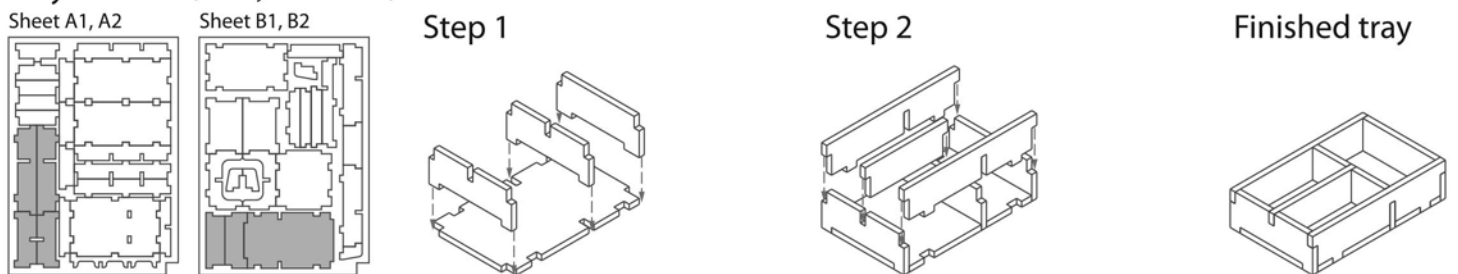

Tray 3

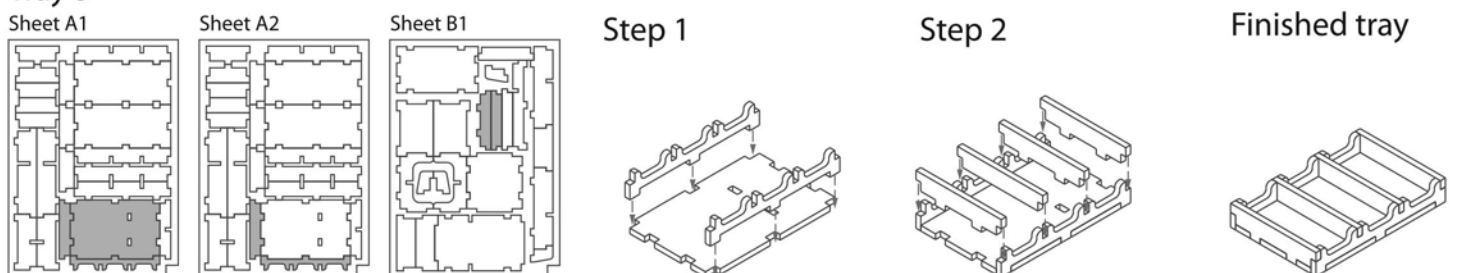

Tray 4a & 4b (the trays are identical)

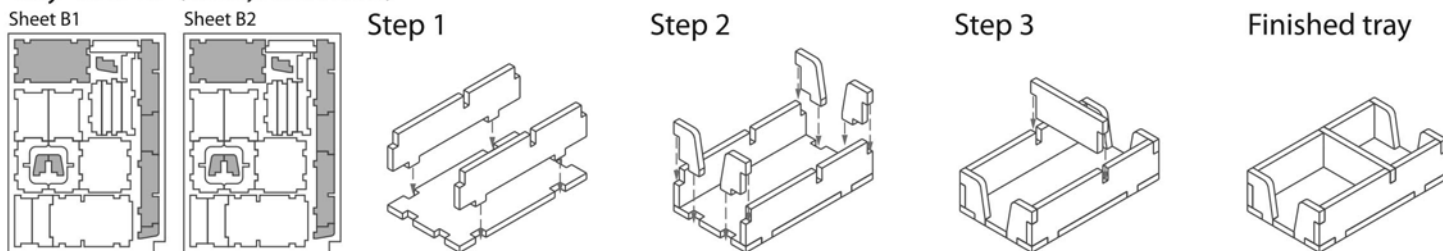

Tray 5a & 5b (the trays are identical)

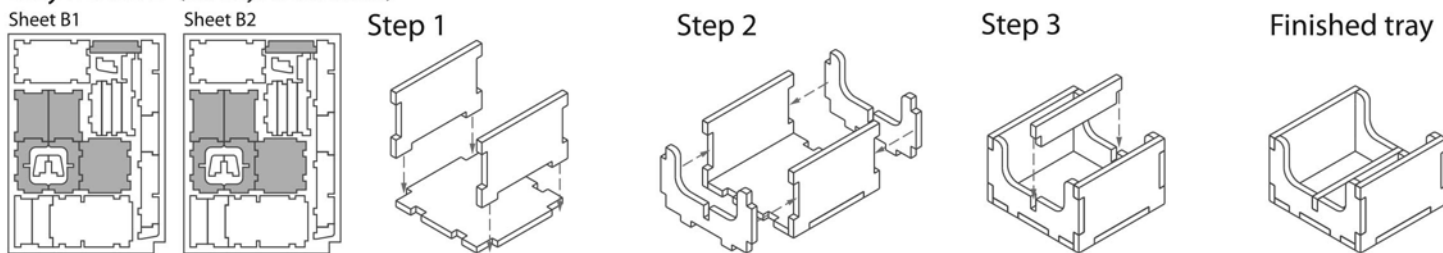

Tray 6

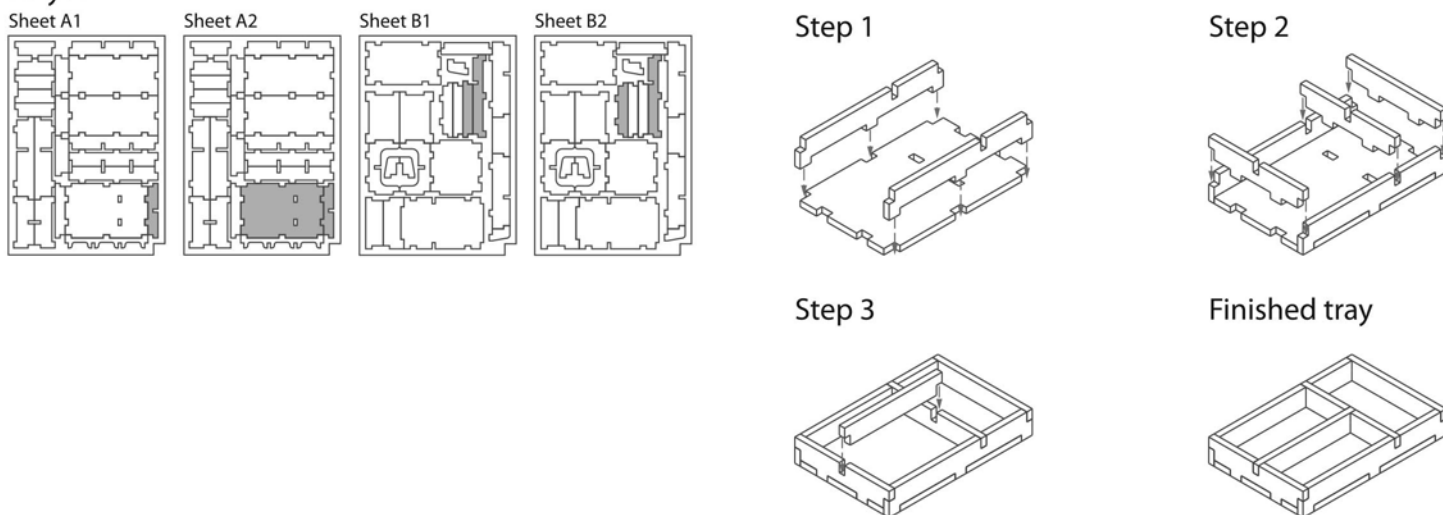

FS-TEO

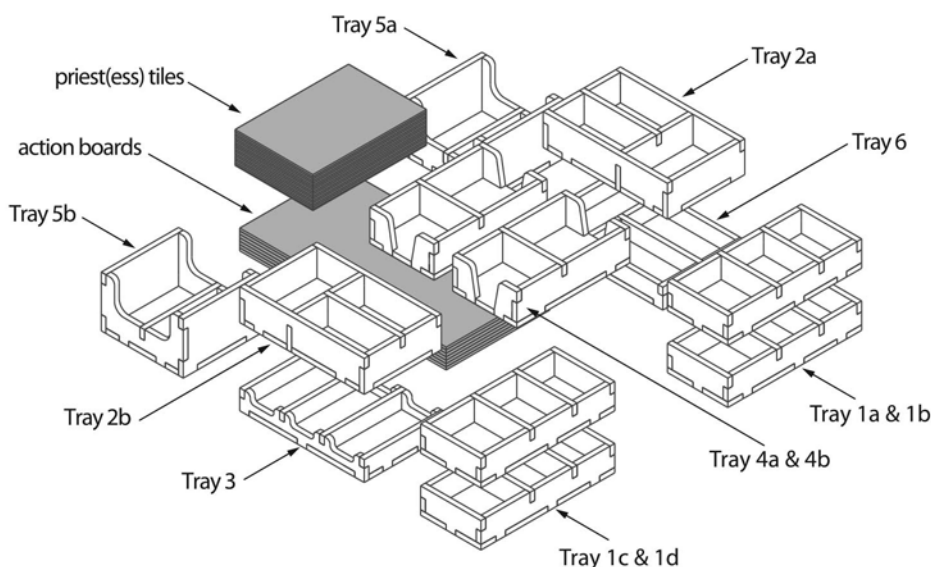

Please check www.foldedspace.net for photos of this insert in use.

Tray legend:

- Tray 1a, b, c, d - player pieces
- Tray 2a - teotibot and cocoa tokens
- Tray 2b - wood, stone and gold
- Tray 3 - discovery tiles
- Tray 4a - technology and starting tiles
- Tray 4b - royal and season tiles
- Tray 5a, b - pyramid tiles
- Tray 6 - calendar discs, buildings, decoration and temple bonus tiles