

FS-AGRFAM insert compatible with Agricola Family Edition®

Assembly Instructions

Notes:

The package contains 3 sheets.

Each tray is doubled.

After assembly the trays are put in two layers in the original game box.

Ordinary PVA glue is required when assembling each tray.

Please make sure you dry-assemble each tray correctly before gluing it together.

Please check www.foldedspace.net for general assembly tips.

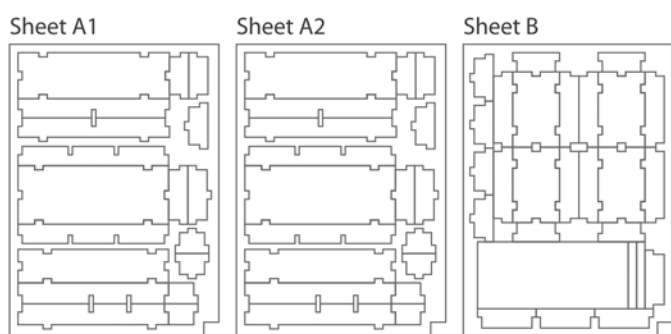
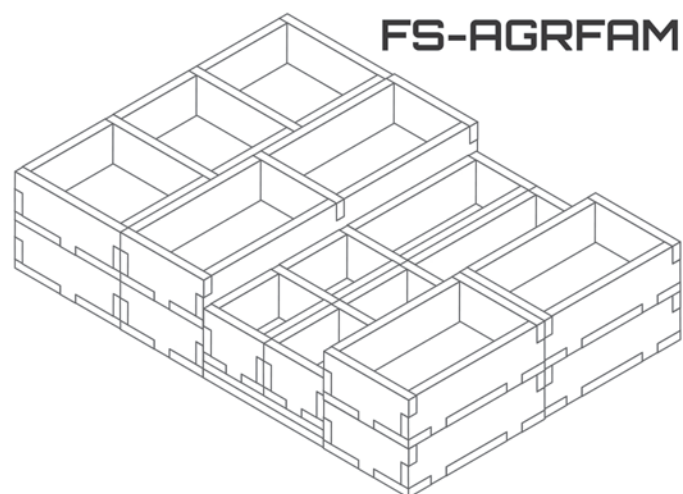

Tray 1a & 1b (the trays are identical)

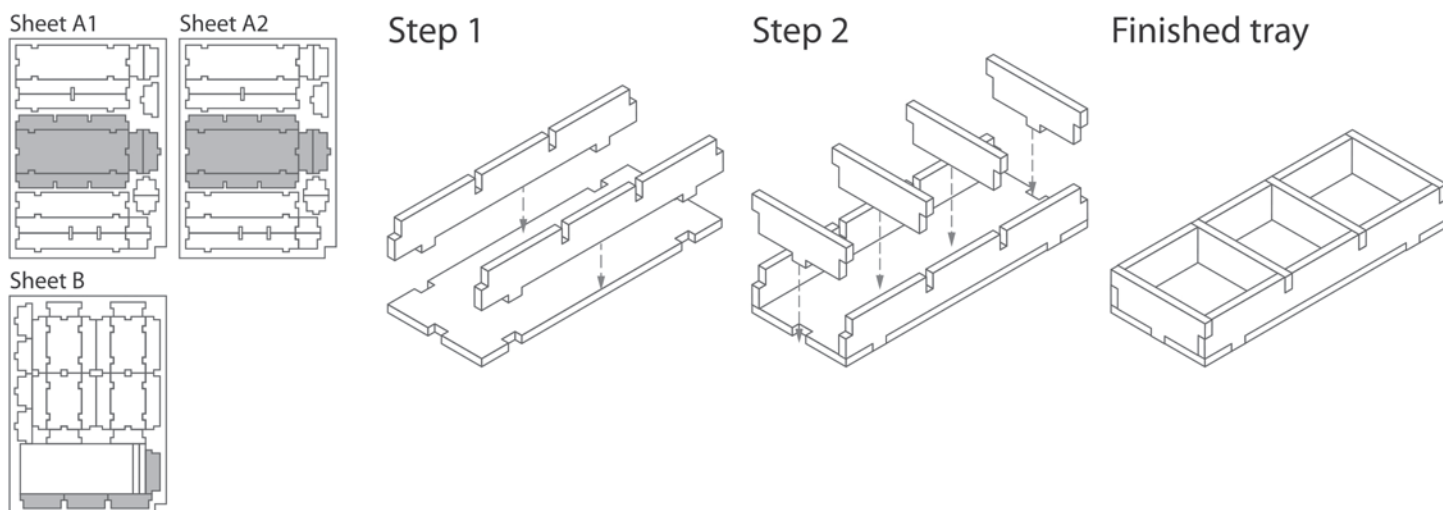

Tray 2a & 2b (the trays are identical)

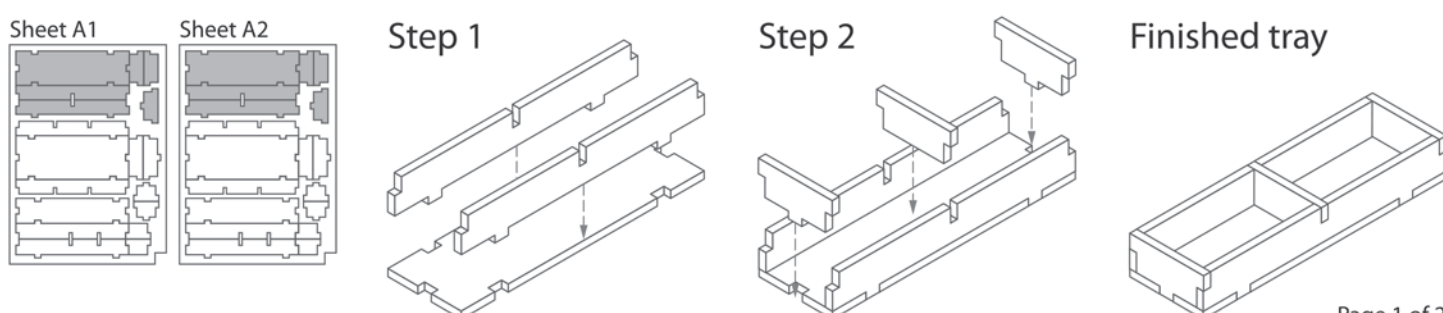

Tray 3a & 3b (the trays are identical)

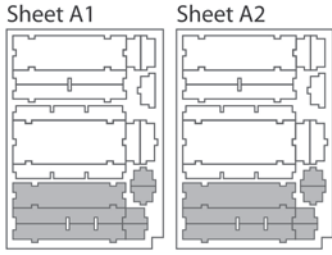

To assemble repeat steps for Tray 1.

Finished tray

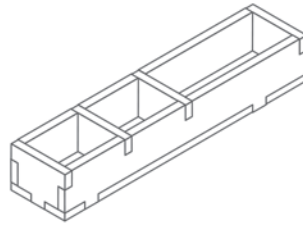

Base for tray 3a & 3b

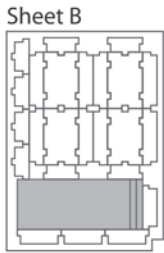

Step 1

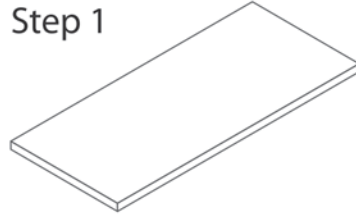

Step 2

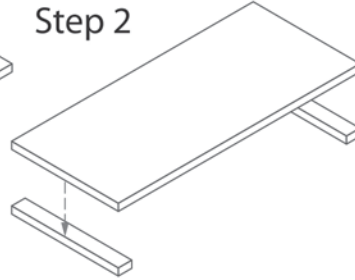

Finished base

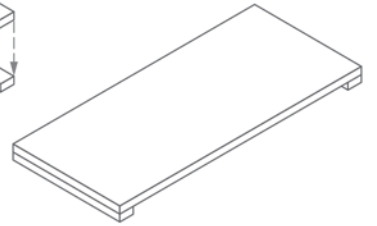

Tray 4a, 4b, 4c & 4d (the trays are identical)

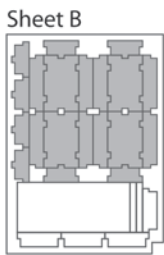

Step 1

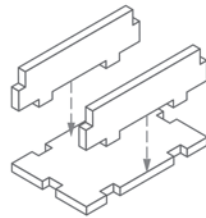

Step 2

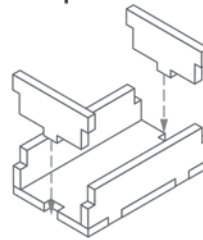

Finished tray

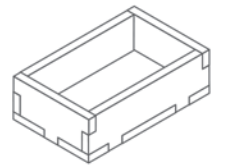

FS-AGRFAM

Please check www.foldedspace.net for photos of this insert in use.

Tip: Keep the instructions in the bottom of your board game box as a reminder of how the insert fits together.

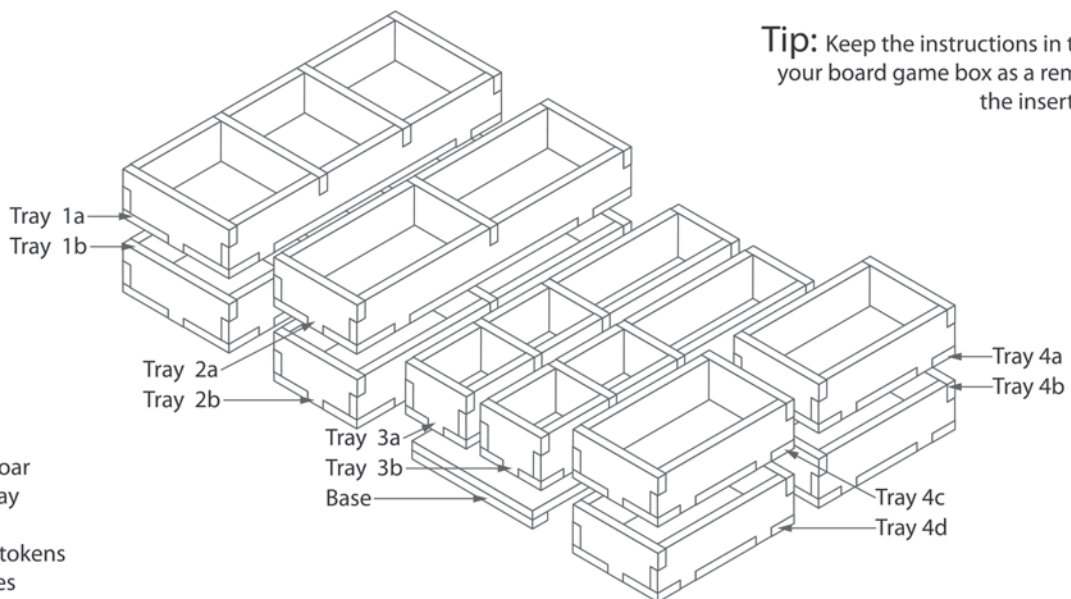

Tray legend:

- Tray 1a - food, sheep, boar
- Tray 1b - cattle, reed, clay
- Tray 2a - grain, wood
- Tray 2b - stables, other tokens
- Tray 3a - rooms, pastures
- Tray 3b - rooms, pastures
- Tray 4a - player pieces
- Tray 4b - player pieces
- Tray 4c - player pieces
- Tray 4d - player pieces

Note: The base for tray 3a & 3b is meant to be left in the game box and not taken out.