

FS-RISDAI insert compatible with

Rising Sun Daimyo Box[®],

with space for the Dynasty Invasion[®], Kami Unbound[®], and Monster Pack[®] expansions



Assembly Instructions

The package contains 8 sheets, four of them are identical to the other four.

After assembly the trays are put in layers in the original game box.

Ordinary PVA glue is required when assembling each tray, for extra strength.

Please make sure you dry-assemble each tray correctly before gluing it together.

Please check www.foldedspace.net for general assembly tips.

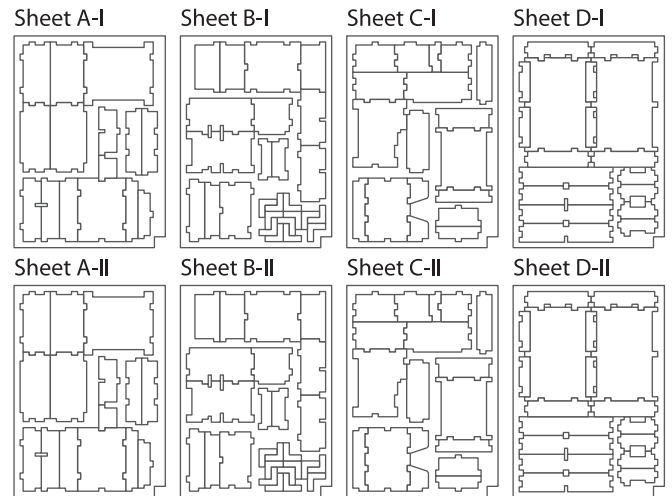

Tray 1

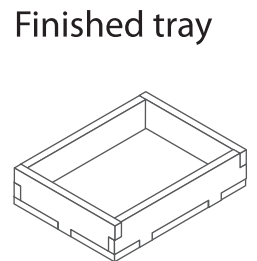
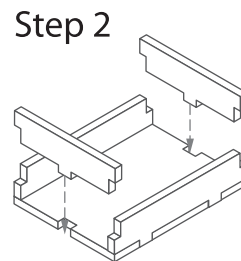
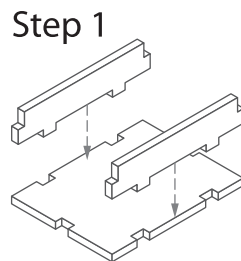
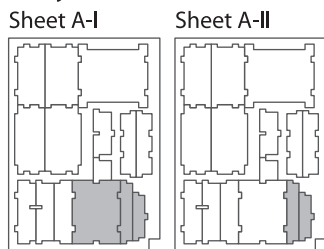

Tray 2

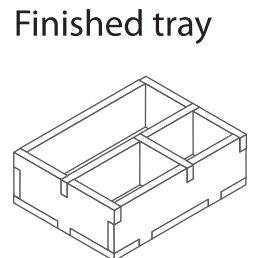
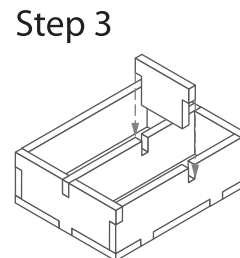
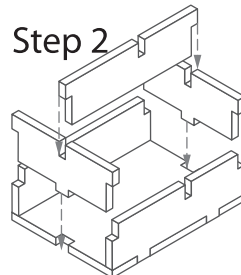
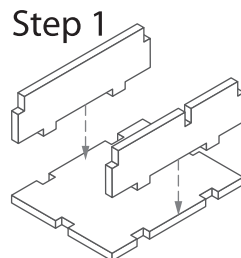
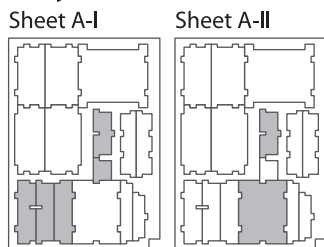

Tray 3

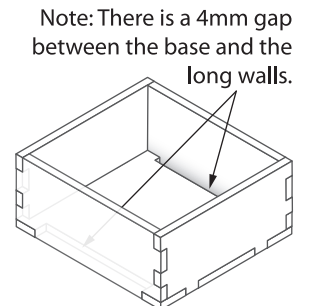
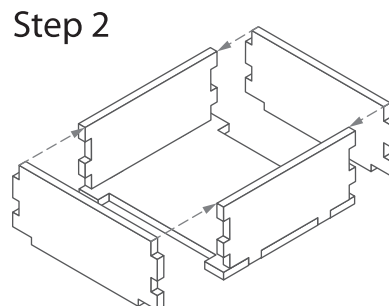
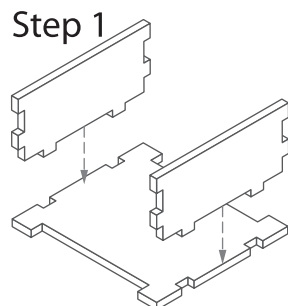
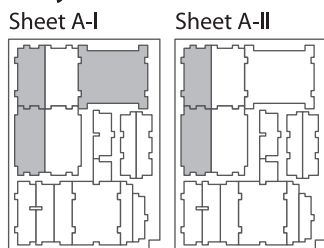

Sheet B-I

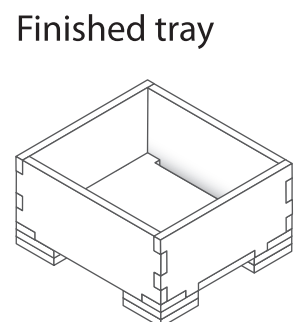
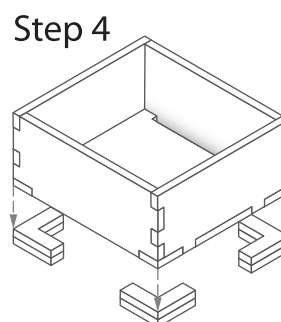
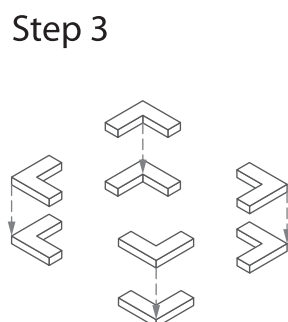
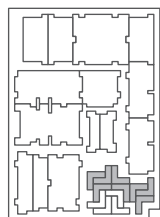

Tip:

Keep the instructions in the bottom of your board game box as a reminder of how the insert fits together.

Tray 4

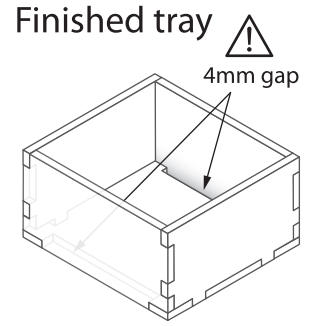
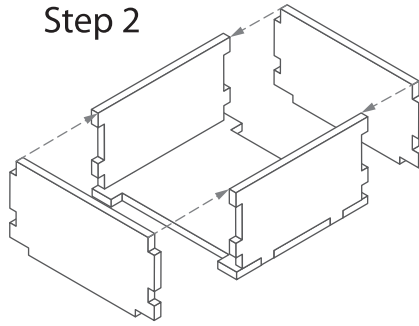
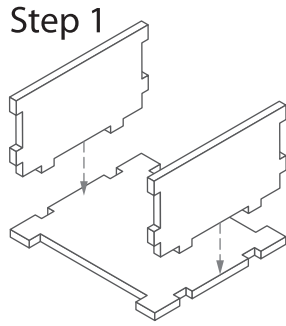
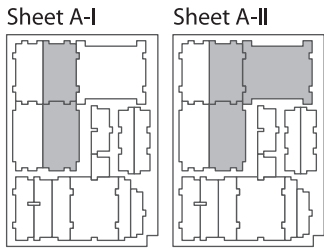

Tray 5a & 5b (the trays are identical)

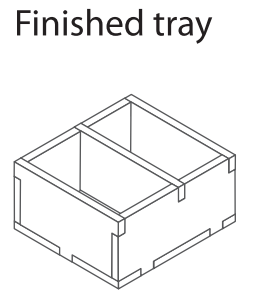
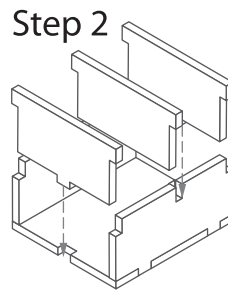
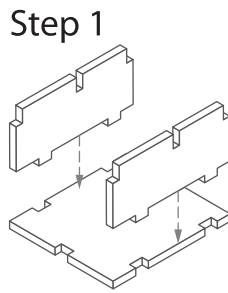
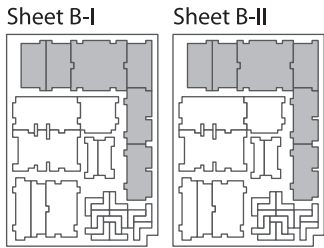

Tray 6

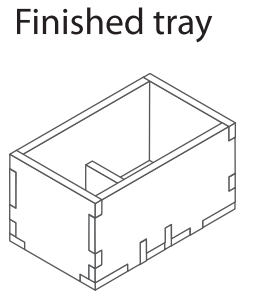
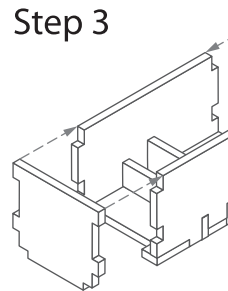
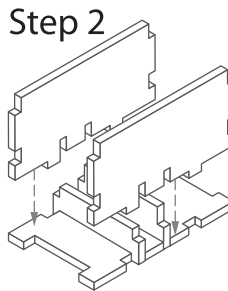
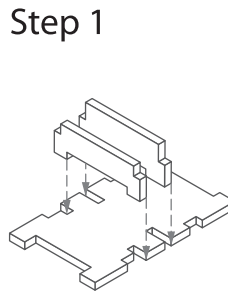
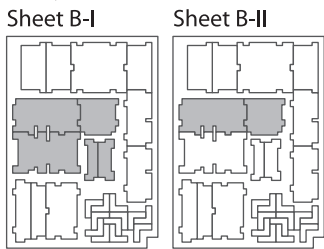

Tray 7

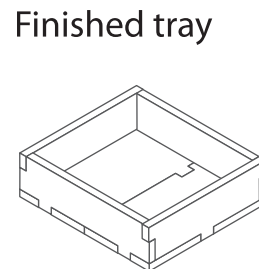
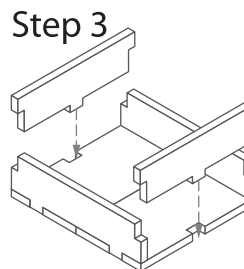
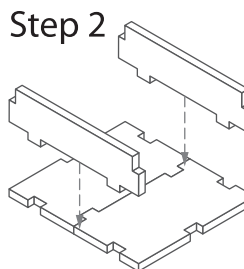
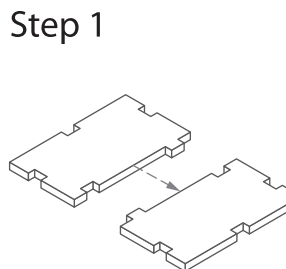
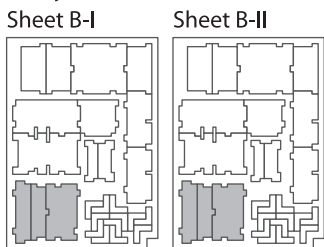

Tray 8

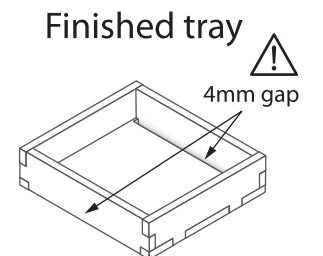
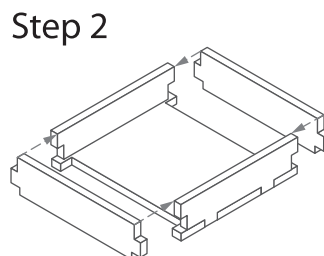
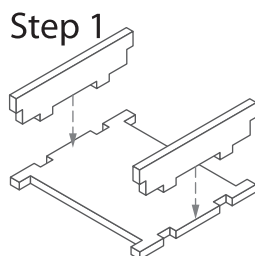
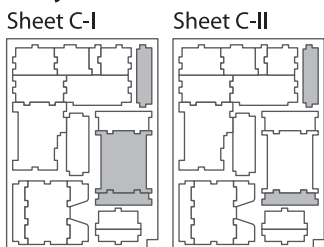

Tray 9

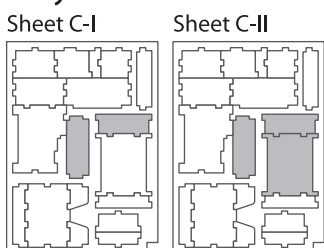

**Assemble
as Tray 8**

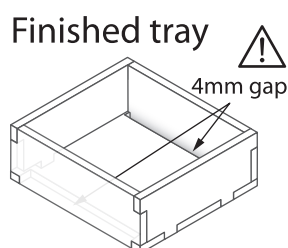

Tray 10a & 10b (the trays are identical)

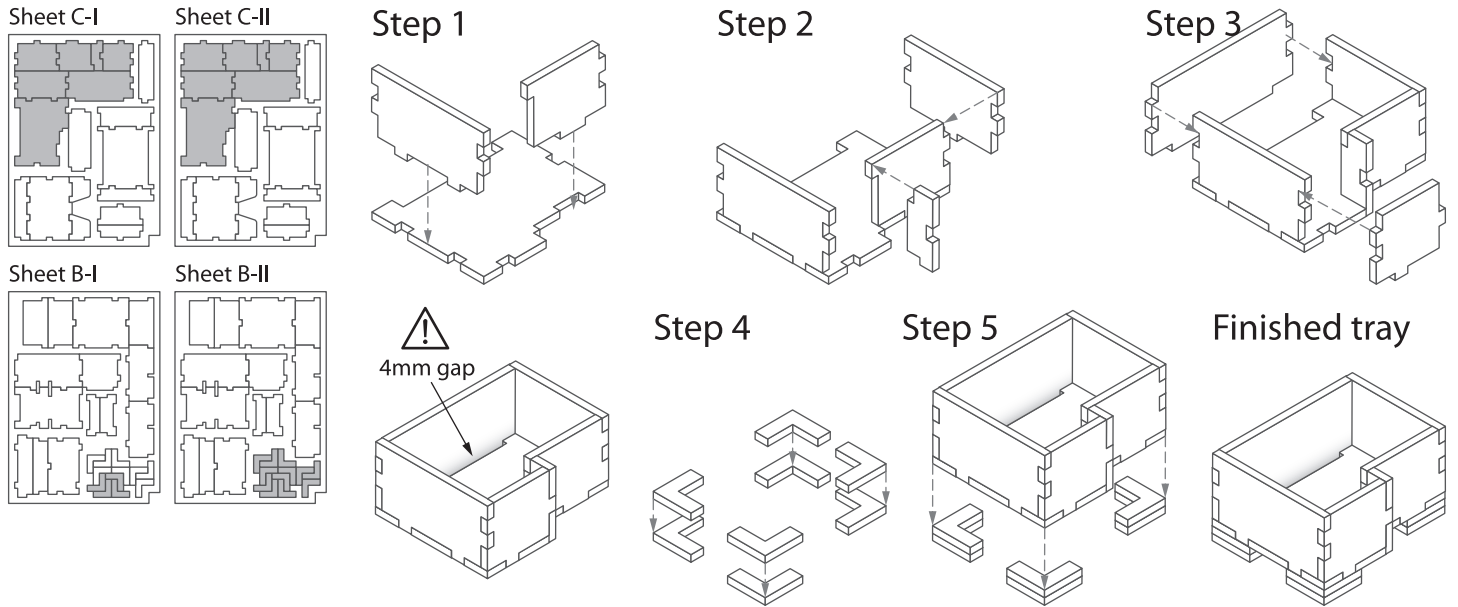

Tray 11

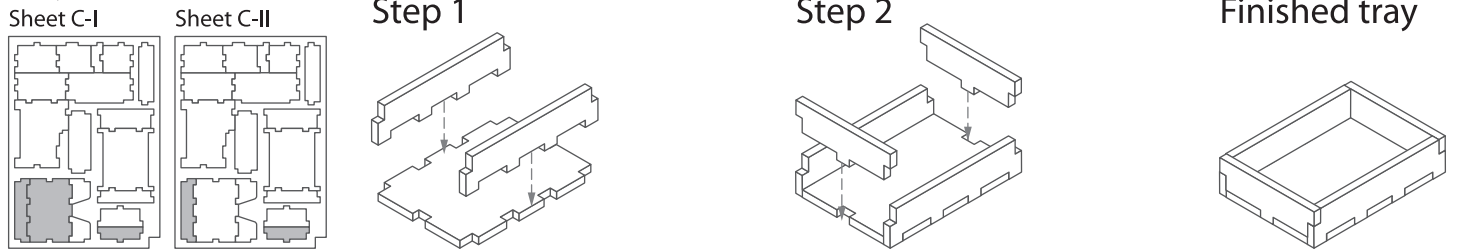

Tray 12

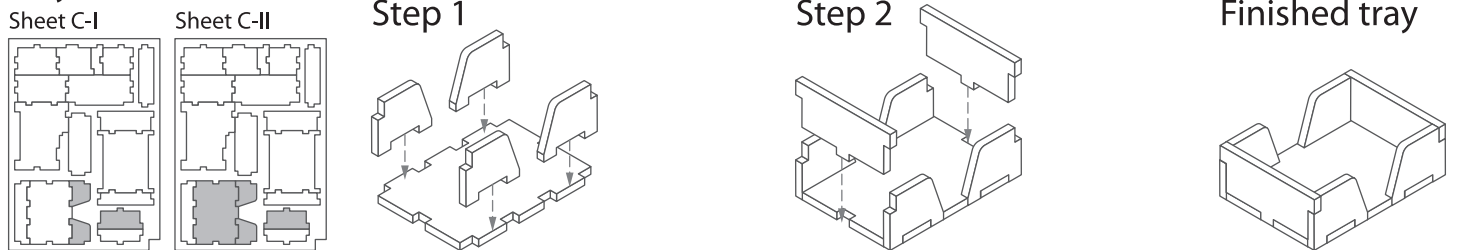

Tray 13a & 13b (identical)

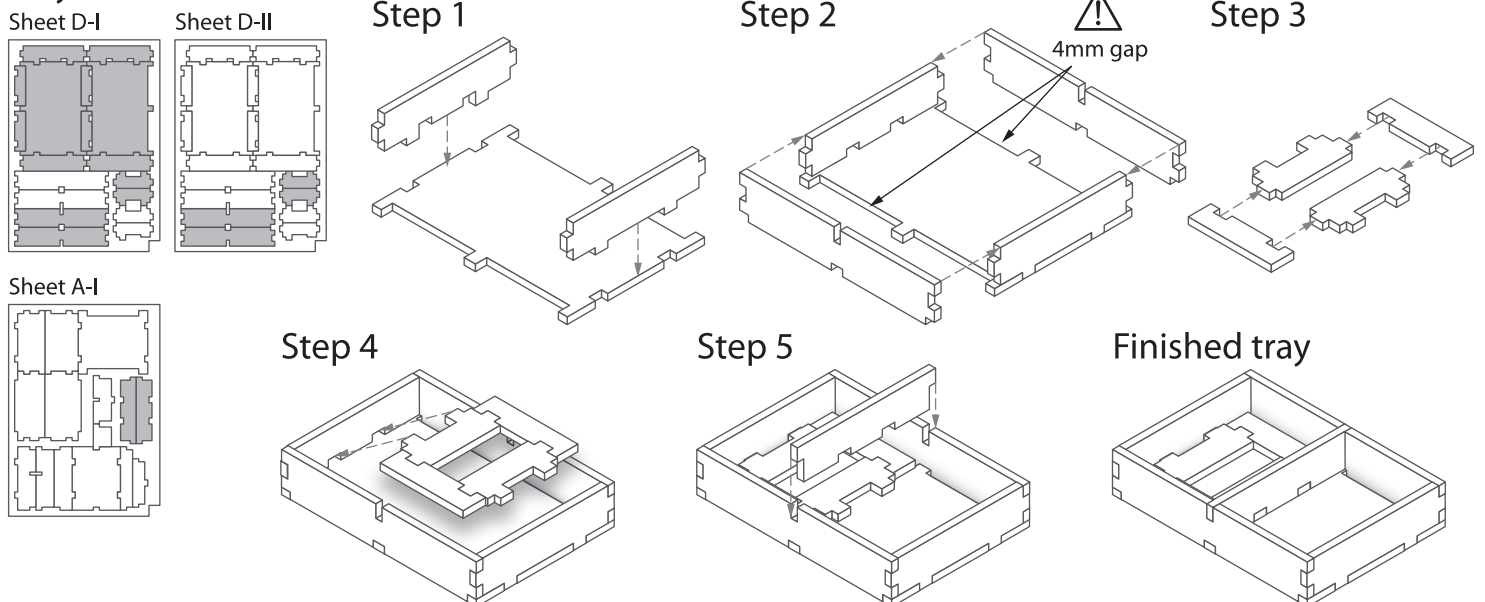

Tray 14

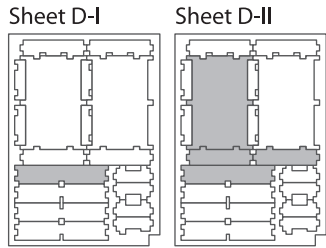

Step 1

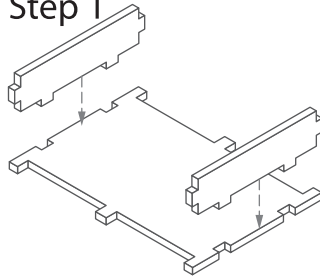

Step 2

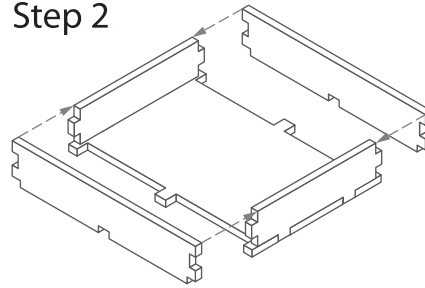

Finished tray

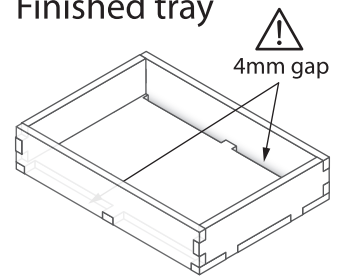

Tray 15

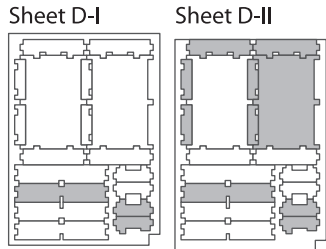

Step 1

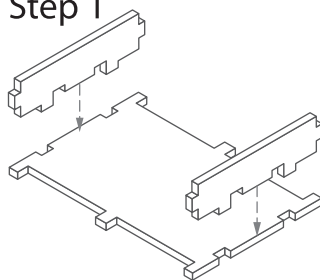

Step 2

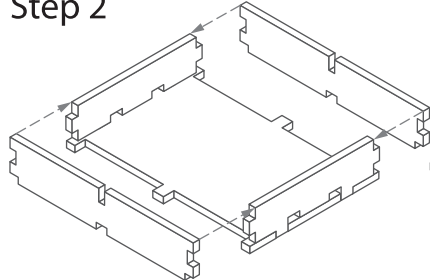

Step 3

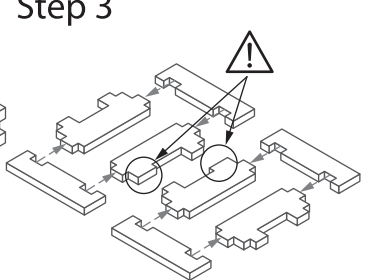

Sheet A-II

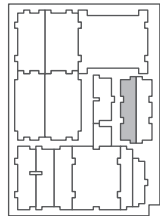

Step 4

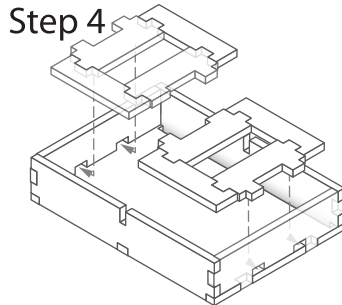

Step 5

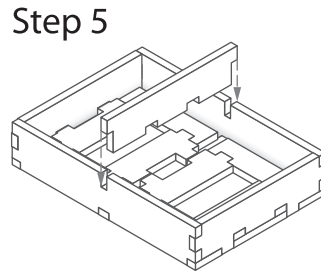

Finished tray

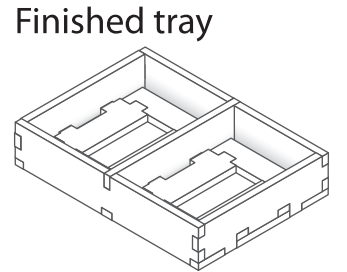

FS-RISDAI

Please check www.foldedspace.net for photos of this insert in use.

Bottom Layers

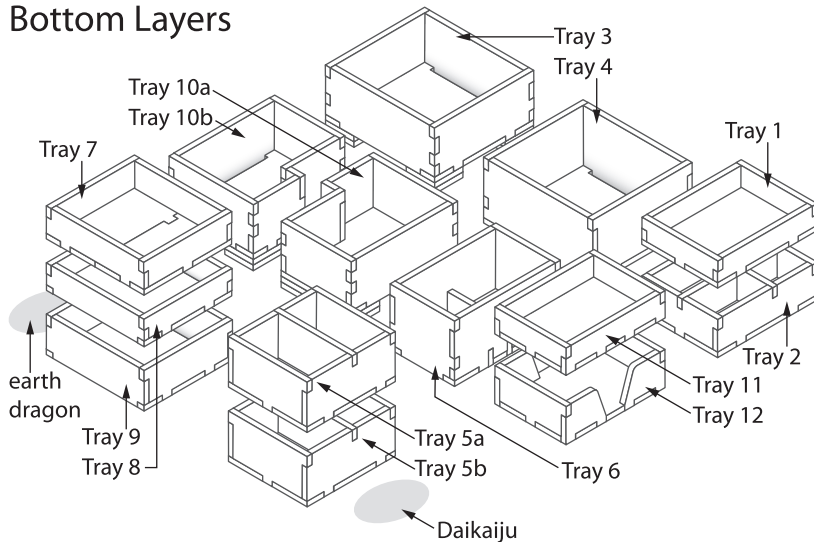

Top Layer

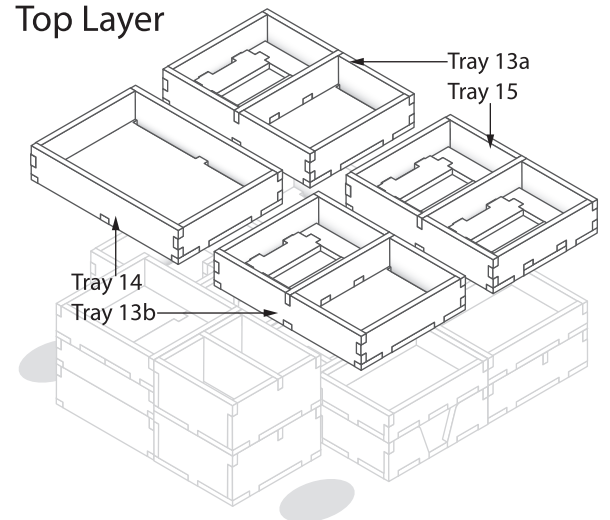

Tray legend:

- Tray 1 - monster bases
- Tray 2 - strongholds and clan markers
- Tray 3 - large monsters (Jinmenju, Nure-onna)
- Tray 4 - huge monster (fire dragon)
- Tray 5a - Raijin kami and Daikokuten
- Tray 5b - kami Susanoo and alliance markers
- Tray 6 - large monster (Oni of Plagues)
- Tray 7 - monster bases
- Tray 8, 9 - kami and medium lucky gods
- Tray 10a - large monsters (sacred warrior, phoenix)
- Tray 10b - large monsters (Jorogumo, Fujin kami)
- Tray 11 - monster bases
- Tray 12 - season cards

- Tray 13a - Fox clan
- Tray 13b - Sun clan
- Tray 14 - Moon clan
- Tray 15 - small lucky gods

Note: While this insert does provide for vertical storage, the game contains many miniatures with protruding weapons that are liable to bend. We recommend for this reason to store the game horizontally.

Finished Insert

