

incl. The Artisans of Naqala®, The Thieves of Naqala®, Whims of the Sultan® and other Djinn card expansions

Assembly Instructions

FS-FIV

The package contains 4 sheets, two of them are identical to the other two.

After assembly the trays are put in two layers in the original game box.

Ordinary PVA glue is required when assembling each tray, for extra strength.

Please make sure you dry-assemble each tray correctly before gluing it together.

Please check www.foldedspace.net for general assembly tips.

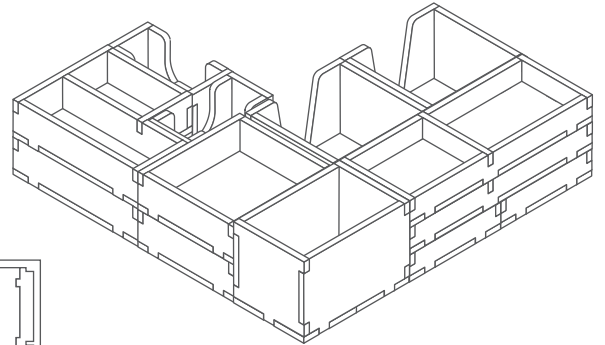

Sheet A

Sheet B

Sheet C

Sheet D

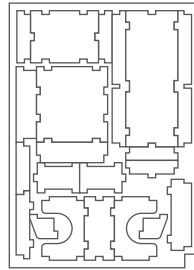
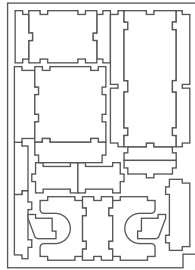
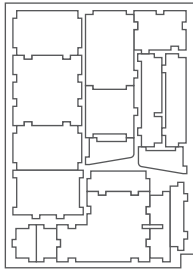
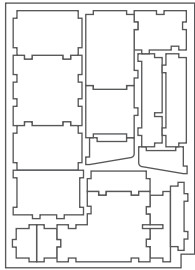

Tray 1a & 1b (the trays are identical)

Sheet A

Sheet B

Step 1

Step 2

Finished tray

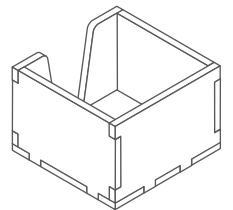
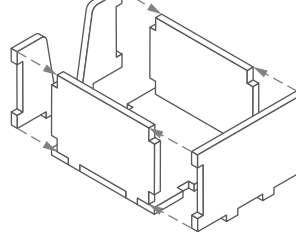
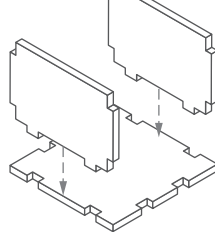
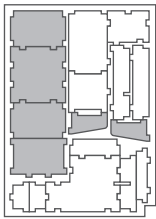
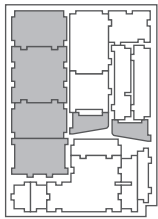

Tray 2

Sheet A

Sheet B

Step 1

Step 2

Step 3

Finished tray

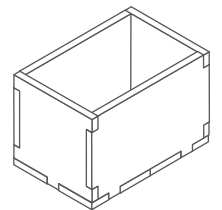
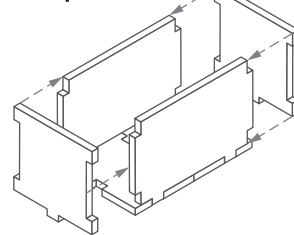
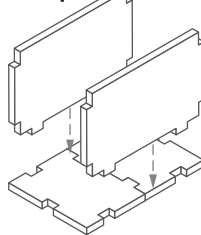
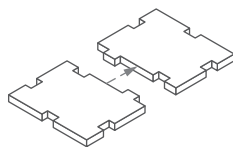
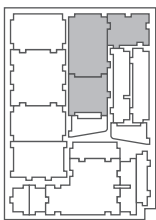
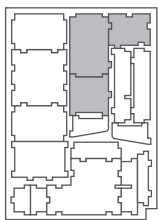

Tray 3a & 3b (the trays are identical)

Sheet A

Sheet B

Step 1

Step 2

Finished tray

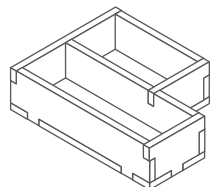
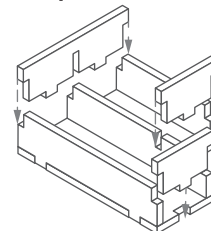
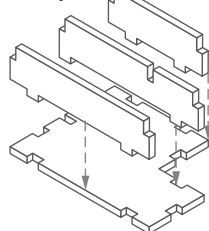
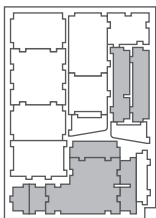
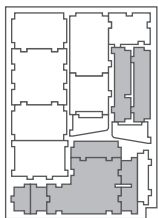

Tray 4a & 4b (the trays are identical)

Sheet C

Sheet D

Step 1

Step 2

Finished tray

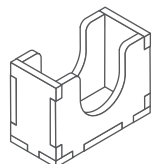
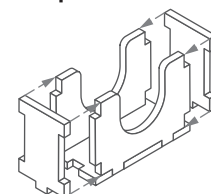
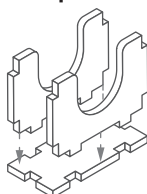
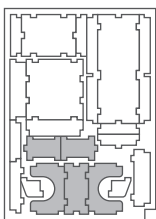
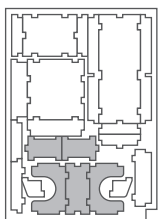

FS-FIV insert compatible with Five Tribes®,

incl. The Artisans of Naqala®, The Thieves of Naqala®, Whims of the Sultan® and other Djinn card expansions



Tray 5

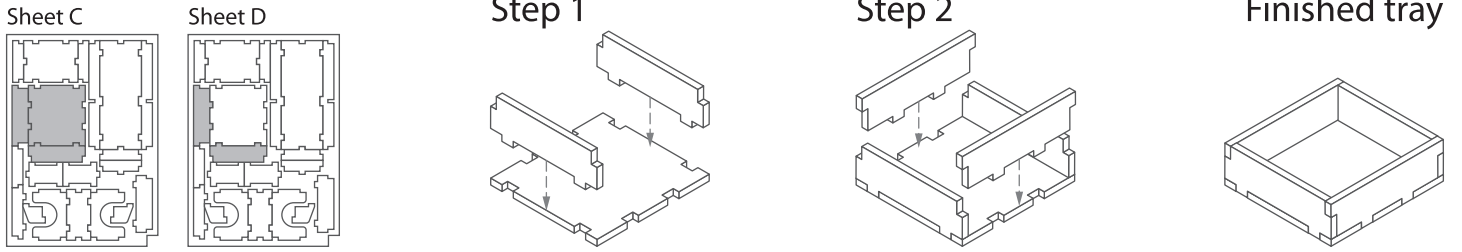

Tray 6

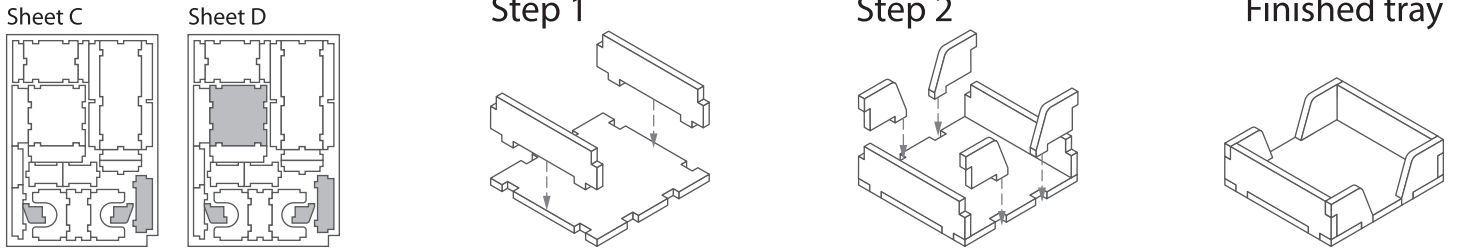

Tray 7a & 7b (the trays are identical)

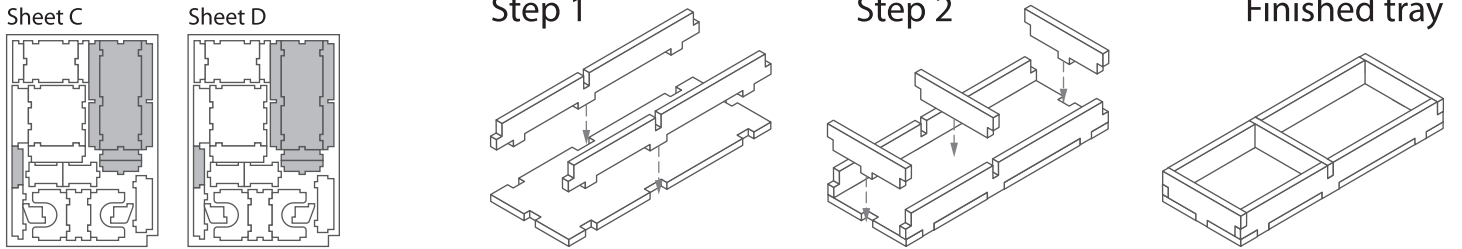

Tray 8a & 8b (the trays are identical)

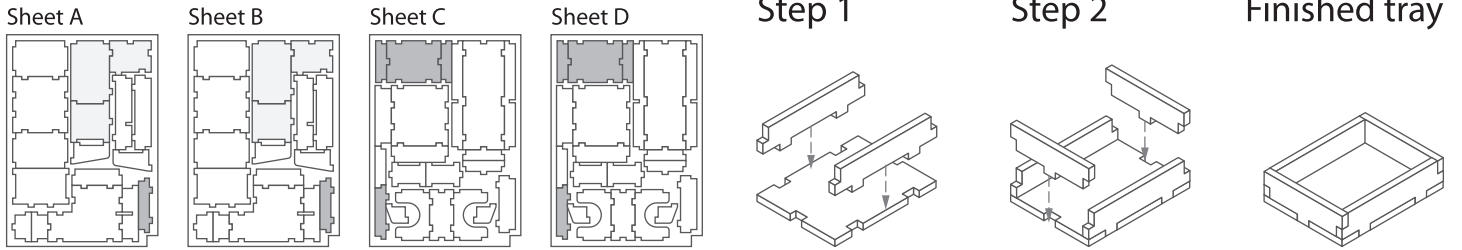

FS-FIV

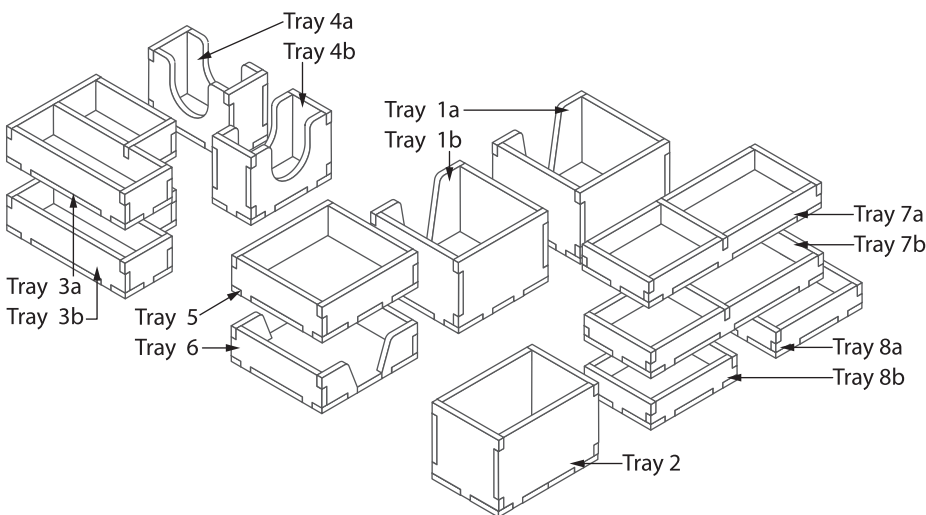

Please check www.foldedspace.net for photos of this insert in use.

Tray legend:

- Tray 1a - place tiles
- Tray 1b - place tiles
- Tray 2 - palm trees and palaces
- Tray 3a - gold coin tokens
- Tray 3b - gold coin tokens
- Tray 4a - resource cards
- Tray 4b - Whim of the Sultan cards
- Tray 5 - mountain pieces
- Tray 6 - djinn cards
- Tray 7a - player pieces
- Tray 7b - player pieces
- Tray 8a - player pieces
- Tray 8b - item markers

Note: Score sheets and meeple bag go in the empty corner space next to trays 1 and 4.

Tip: Keep the instructions in the bottom of your board game box as a reminder of how the insert fits together.